

# **Alaska Railroad Corporation**



## **Timetable No. 131**

**Effective**

**00:01 Sunday**

**April 20, 2003**

**Alaska Daylight Time**

**Patrick Gamble**

**President and Chief Executive Officer**

**Matthew G. Glynn**

**Vice President and Chief Operating Officer**

**Robert B. Stout**

**Vice President and Chief Mechanical Officer**

**Patrick C. Shake**

**Superintendent, Transportation**

**Steven W. Pfeiffer**

**Assistant Vice President, Maintenance**

<b>Signal Displayed</b>	<b>Is it in Writing?</b>	<b>Is Stop in the Stop Column? *</b>	<b>Is a Red Flag Displayed</b>	<b>Action to Take Two Miles Beyond Signal</b>	<b>Type of Flag at End of Restricted Area if Displayed</b>
1) Yellow/Red	Yes	Yes	Yes	STOP (do not proceed without permission from EIC)	No Flag Displayed
2) Yellow/Red	Yes	No	Yes	STOP (proceed only as in no.1)	No Flag Displayed
3) Yellow/Red	Yes	Yes	No	STOP (proceed only as in no.1)	No Flag Displayed
4) Yellow/Red	No	N/A	Yes	STOP (proceed only as in no.1)	No Flag Displayed
5) Yellow/Red	No	N/A	No	Proceed thru limits at restricted speed	No Flag Displayed -or- as directed by EIC -or- leading end of train has traveled 4 miles from yellow/red and dispatcher confirms no Form B in effect
6) Yellow	Yes	N/A	N/A	Proceed at speed as prescribed	Green Flag -or- rear car has cleared the restriction
7) Yellow	No	N/A	N/A	10 MPH	Green Flag -or- rear car has traveled 4 miles from the yellow flag and dispr confirms no restriction

\*On ARRC all Form B Territories will be protected by STOP in the STOP column

# Timetable

## No. 131

To make an emergency phone call from a radio telephone to FIRE/POLICE/MEDICAL, enter \* 1, wait for dial tone, enter 9 for commercial dial tone, then enter 9 1 1. You will be connected to Emergency Services in Anchorage. It may take up to ten seconds for the operator to answer — DO NOT HANG UP.

---

---

Dispatcher, Maintenance of Way, and Yard (except channel 6) radio frequencies all have **9 1 1 emergency** call-in capability. Once activated, the radio will answer back with a short tone, followed by three beeps, then another short tone, acknowledging the call has been received by the dispatcher radio system.

---

---

The telephone number for the ARRC Command Center (when activated) is 265-2581.

## **A Single Second**

It takes a minute to write a safety rule.

It takes an hour to hold a safety meeting.

It takes a week to plan a good safety program.

It takes a month to put that program into operation.

It takes a year to win a safety award.

It takes a lifetime to make a safe worker.

But it takes only a second to destroy it all - with one accident.

Take the time now to work safe and help your fellow  
employees to be safe.

---

Table of Contents

Station Column Abbreviations .....	9
80.0 Seward Subdivision .....	11
80.1 Seward Subdivision .....	11
80.1.1 Method of Operation .....	12
80.1.2 Maximum Authorized Speeds .....	12
80.1.3 Location of Other Tracks .....	13
80.1.4 Siding Switch Locations .....	14
80.1.5 Measured Miles .....	14
80.2 Excepted Track .....	14
80.3 Call-Up Stations .....	15
80.4 Seward .....	15
80.5 Divide .....	16
80.6 Crown Point .....	16
80.7 Moose Pass .....	16
80.8 Hunter .....	16
80.9 Grandview .....	17
80.10 Doubling Grandview Hill .....	17
80.11 MP 50 .....	17
80.12 Tunnel .....	17
80.13 Spencer .....	17
80.14 MP 62.8 Snow Fleet Track .....	18
80.15 Portage .....	18
80.16 Girdwood .....	19
80.17 Brookman .....	19
80.18 Indian .....	19
80.19 Rainbow .....	19
80.20 Potter .....	19
80.21 Turnagain .....	20
80.22 QAP MP 108.4 .....	20
80.23 Campbell .....	20
80.24 CP 1139 (OVL) .....	20
80.25 Anchorage .....	20
80.26 Anchorage International Airport Branch .....	21
80.26.1 Method of Operation .....	21
80.26.2 Maximum Authorized Speeds .....	21
80.26.3 Location of Other Tracks .....	21
80.26.4 Airport Branch Junction, MP J 0.0 .....	22
80.26.5 Anchorage International Airport Terminal, MP J 2.45 .....	22

## Table of Contents

---

80.27	Seward Subdivision Grade Profile .....	22
81.0	Whittier Subdivision .....	25
81.1	Whittier Subdivision .....	25
81.1.1	Method of Operation .....	25
81.1.2	Maximum Authorized Speeds .....	25
81.1.3	Location of Other Tracks .....	26
81.1.4	Siding Switch Location .....	26
81.1.5	Measured Mile .....	26
81.2	Location of Tunnel Doors .....	26
81.3	Excepted Track .....	26
81.4	Whittier .....	27
81.5	Whittier Subdivision Tunnels .....	28
81.6	Emergency Telephones in Whittier Subdivision Tunnels .....	29
81.7	Whittier Tunnel Signal System (TSS) .....	29
81.7.1	Train Movements .....	30
81.7.2	On-Track Movements .....	30
81.7.3	Foul Time .....	31
81.7.4	Switch Point Derails .....	31
81.7.5	Highway Vehicle Crossing Gates .....	31
81.7.6	Whittier Tunnel Signal System Malfunction .....	32
81.8	Bear Valley .....	32
81.9	Portage .....	32
81.10	Whittier Subdivision Grade Profile .....	32
82.0	Anchorage Subdivision .....	35
82.1	Anchorage Subdivision .....	35
82.1.1	Method of Operation .....	37
82.1.2	Maximum Authorized Speeds .....	37
82.1.3	Siding Switch Locations .....	39
82.1.4	Location of Other Tracks .....	40
82.1.5	Measured Miles .....	42
82.2	Excepted Track .....	42
82.3	Call-Up Stations .....	43
82.4	Anchorage .....	43
82.5	MP 117 Crossover to SW MP 119.8 .....	45
82.6	Fort Richardson .....	46
82.7	MP 123 .....	46
82.8	Reves .....	46
82.9	Powder Spur MP 131 .....	46
82.10	Birchwood .....	46
82.11	Eklutna .....	47

82.12	Matanuska .....	47
82.13	Palmer Junction .....	47
82.14	Spenard Builders Supply MP 158.7 .....	48
82.15	Wasilla .....	48
82.16	Spenard Builders Supply MP 161.6 .....	48
82.17	Pittman .....	48
82.18	Houston .....	49
82.19	Willow .....	49
82.20	Kashwitna .....	49
82.21	Caswell .....	49
82.22	Montana .....	49
82.23	Montana Creek Bridge, MP 211 .....	50
82.24	Sunshine .....	50
82.25	Log Track MP 223.6 .....	50
82.26	Talkeetna .....	50
82.27	Chase .....	51
82.28	Curry .....	51
82.29	Susitna .....	51
82.30	Sherman .....	51
82.31	Gold Creek .....	51
82.32	Canyon .....	51
82.33	Chulitna .....	52
82.34	Hurricane .....	52
82.35	Honolulu .....	52
82.36	Colorado .....	52
82.37	Broad Pass .....	53
82.38	Summit .....	53
82.39	Cantwell .....	53
82.40	Windy .....	53
82.41	MP 333.7 House Track .....	53
82.42	Carlo .....	54
82.43	Oliver .....	54
82.44	Denali Park .....	54
82.45	Cascade Outfit Track .....	54
82.46	Garner .....	54
82.47	Healy Canyon Between Denali Park and Healy .....	55
82.48	Garner Tunnel .....	55
82.49	Healy .....	55
82.50	Usibelli Tipple .....	56
82.51	Ferry .....	58
82.52	Bear Creek .....	58
82.53	Browne .....	58

## Table of Contents

---

82.54	MP 388 Pit Track .....	58
82.55	Clear Site .....	59
82.56	Mile Posts 394 A and 394 B .....	59
82.57	Maintenance Track MP 401.1 .....	59
82.58	Nenana .....	59
82.59	North Nenana .....	60
82.60	Manley .....	60
82.61	Dunbar .....	60
82.62	Outfit Track MP 432.6 .....	60
82.63	Standard .....	61
82.64	Saulich .....	61
82.65	Dome .....	61
82.66	Happy .....	61
82.67	Fairbanks .....	61
82.68	Palmer Branch .....	63
82.68.1	Method of Operation .....	63
82.68.2	Maximum Authorized Speeds .....	63
82.68.3	Location of Other Tracks .....	63
82.68.4	Palmer Branch Special Instructions .....	64
82.69	Suntrana Branch .....	65
82.69.1	Method of Operation .....	65
82.69.2	Maximum Authorized Speeds .....	65
82.69.3	Suntrana Branch Special Instructions .....	65
82.70	Fairbanks International Airport Branch .....	66
82.70.1	Method of Operation .....	66
82.70.2	Maximum Authorized Speeds .....	66
82.70.3	Location of Other Tracks .....	66
82.70.4	Fairbanks International Airport Branch special instructions ..	67
82.71	Eielson Branch .....	68
82.71.1	Method of Operation .....	68
82.71.2	Maximum Authorized Speeds .....	68
82.71.3	Location of Other Tracks .....	68
82.71.4	Eielson Branch Special Instructions .....	69
82.72	Anchorage Subdivision Grade Profiles .....	71
83.0	Special Instructions, All Subdivisions .....	75
83.1	General Orders .....	75
83.2	Operating Circulars .....	75
83.3	Track and Time .....	75
83.4	Minimum Flagging Distance .....	75
83.5	Train Operations at Sidings .....	76



83.6	Maximum Speeds Permitted and Instructions for Handling Special Equipment .....	76
83.7	Switch Alignment .....	78
83.8	Derails .....	79
83.9	Switching/Train Makeup Restrictions .....	79
83.10	Loading and Handling Heavy Equipment .....	80
83.11	Setting Out Cars .....	80
83.12	Excessive Height Cars and Loads .....	81
83.13	Clearance of High, Wide and Heavy Loads .....	82
83.14	Loading Clearance Diagrams .....	83
83.15	Heavy Loads .....	84
83.16	Standard Hopper Car Loading Capacity .....	84
83.17	Loading Placement of TOFC Containers .....	85
83.18	Slide Zones .....	86
83.19	Avalanche Detection System .....	88
83.20	Movement Over Bridges .....	88
83.21	Dragging Equipment Detectors and/or Defect Detectors .....	89
83.22	Highway Crossing Signals .....	93
83.23	Grade Crossing/Highway Crossing Cross Reference .....	95
83.24	Radio Communications .....	100
83.25	Dispatcher Call on Touch Pad-Equipped Radios .....	103
83.26	Radio Telephone Operation .....	104
83.27	Radio Base and Wayside Station Locations, Times Attended and Assigned Channels .....	105
83.28	Maintenance of Way Radios .....	105
83.29	Game Animals/Livestock .....	106
83.30	Fixed Signals .....	106
83.31	Determining Number of Hand Brakes to Apply .....	116
83.32	Signal Aspects and Indications, GCOR Rule 9.1 .....	116
84.0	General Code of Operating Rules .....	117
85.0	Alaska Railroad Safety Manual .....	125
22.5	Dark Lens Eye Protection .....	125
29.2.1	Getting On and Off Moving Equipment .....	125
31.2.1	Going between Cars Coupled to Locomotives or between Locomotives Coupled to Locomotives .....	125
43.2.6	Flag Location .....	127
43.7	Requesting and Using Track Bulletin Form B .....	127
44.3	Wearing Seat Belts .....	128
44.7	Backing Up .....	128

## Table of Contents

---

58.4.2	Non-Controlled Track .....	128
58.6	Audible Warning from Trains .....	129
86.0	Air Brake and Train Handling Rules .....	131
86.1	Air Brake and Train Handling Manual Rule Changes .....	131
86.2	Locomotive Special Handling .....	133
86.3	Locomotive Head End Power Operating Instructions .....	136
86.4	Caboose Special Handling .....	139
86.5	Baggage Car Generators .....	139
86.6	En route Operation of GVs (Generator Vans) GV-01, GV-02, GV-03 .....	141
86.7	End of Train Devices .....	143
86.8	Brake Cutouts on Locomotives .....	145
90.0	Hazardous Material Handling .....	147
90.1	Hazardous Material Handling Instructions Booklet .....	147
	Job Briefing .....	149
	Speed Table .....	153

## STATION COLUMN ABBREVIATIONS

The following letters, when placed in the columns provided in Timetable, indicate:

B — General Orders	C — Call Up Station	J — Junction
L — Loop Track	X — Yard Limits	P — Telephone
W — Water	Y — Wye	Z — Track Scale

**The grade profiles shown in this Timetable are an addition to the track chart and must not be used to determine the minimum number of hand brakes to apply to hold equipment on a grade.**

*It only takes a  
minute to prevent  
an accident, but it  
can take a lifetime  
to recover from one.*

*Noise annoys,  
then destroys.  
Wear your hearing  
protection.*

*If you are aware  
of it,  
take care of it.*

**80.0 SEWARD SUBDIVISION****80.1 SEWARD SUBDIVISION**

SOUTH ↓		Main Track		↑ NORTH	
Call Code	Capacity of siding	STATIONS	Mile Post	Meth. of Opr.	Detector Locations
00		Anchorage 5.0	BWXYZ 114.3	YL CTC	
05	7,864	Campbell 3.1	109.3	YL	
	12,314	Turnagain 5.6	106.2	TWC	104.6 B
	2,176	Potter 7.1	100.6		
	850	Rainbow 4.8	93.2		
	4,826	Indian 7.0	88.7		88.0 B
	2,508	Brookman 7.2	81.7		
	1,892	Girdwood 10.3	74.5		75.0 C
04	2,453	Portage 8.4	CJY 64.2		63.0 B
	3,051	Spencer 4.7	55.8		
	1,160 N	Tunnel 6.2	W 51.1		
	2,290	Grandview 4.9	44.9		42.2 A
01	4,533	Hunter 10.7	CY 40.0		
02	990	Moose Pass 4.8	29.3		29.4 B
	3,706	Crown Point 12.5	24.5		18.4 B
	1,920	Divide 9.1	12.0		14.3 A
00		Seward BWXYY	2.9	YL	

**80.1.1 METHOD OF OPERATION**

LOCATION	METHOD OF OPERATION
MP 2.90 - MP 3.40	YL
MP 3.40 - MP 113.00	TWC
MP 113.00 - MP 113.85	YL
MP 113.85 - MP 113.90	CTC
MP 113.90 - MP 114.30	YL

**80.1.2 MAXIMUM AUTHORIZED SPEEDS**

Maximum Authorized Speed Between:	In MPH For:	
	Frt	Psgt
MP 2.90 and MP 3.40 (Yard Limit) .....	20	20
MP 3.40 and MP 8.10 .....	35	35
MP 8.10 and MP 20.45 .....	25	25
MP 20.45 and MP 22.90 .....	35	35
MP 22.90 and MP 23.40 .....	25	25
MP 23.40 and MP 25.60 .....	35	35
MP 25.60 and MP <b>29.50</b> .....	25	25
<b>MP 29.50 and MP 29.55</b> .....	<b>10</b>	<b>10</b>
<b>MP 29.55</b> and MP 33.20 .....	25	25
MP 33.20 and MP 40.50 .....	35	40
MP 40.50 and MP 42.50 .....	25	25
MP 42.50 and MP 44.55 .....	20	20
MP 44.55 and MP 47.50 .....	25	25
MP 47.50 and MP 53.00 .....	15	15
MP 51.80 and MP 53.00 Northward .....	10	10
MP 53.00 and MP 53.65 .....	20	20
MP 53.65 and <b>MP 63.80</b> .....	49	49
<b>MP 63.80</b> and MP 66.00 .....	30	30
MP 66.00 and MP 66.80 .....	25	25
MP 66.80 and MP 69.33 .....	30	30
MP 69.33 and MP 69.50 .....	25	25
MP 69.50 and MP 70.26 .....	30	30
MP 70.26 and MP 70.45 .....	25	25
MP 70.45 and MP 71.45 .....	25	30

## Seward Subdivision Special Instructions

MP 71.45	and MP 73.00	.....	25	25
MP 73.00	and MP 74.00	.....	30	30
MP 74.00	and MP 83.85	.....	35	35
MP 83.85	and MP 84.20	.....	25	25
MP 84.20	and MP 85.00	.....	25	30
MP 85.00	and MP 85.71	.....	25	25
MP 85.71	and MP 89.50	.....	30	30
MP 89.50	and MP 93.15	.....	40	40
MP 93.15	and MP 93.85	.....	35	35
MP 93.85	and MP 100.00	.....	40	40
MP 100.00	and MP 105.00	.....	45	45
MP 105.00	and MP 108.80	.....	30	30
<b>MP 108.80</b>	<b>and MP 112.00</b>	.....	<b>25</b>	<b>25</b>
<b>MP 112.00</b>	<b>and MP 113.00</b>	.....	<b>15</b>	<b>20</b>
<b>MP 113.00</b>	<b>and MP 113.85 (Yard Limits)</b>	.....	<b>15</b>	<b>20</b>
<b>MP 113.85</b>	<b>and MP 113.90</b>	.....	<b>15</b>	<b>20</b>
MP 113.90	and MP 114.30 (Yard Limit)	.....	10	20

### 80.1.3 LOCATION OF OTHER TRACKS

MP	Name	Switch Location	Capacity in feet
24.40	Phillips Spur	S	270
29.30	Ramp Track, off siding	N	236
40.00	Hunter Wye		450
55.82	Gravel Pit	N	3,632
62.80	Snow Fleet	S	394
63.89	South Leg, Portage Wye	S	
64.30	North Leg, Portage Wye	N	
<b>105.58</b>	<b>Turnagain Ramp Track</b>	<b>N</b>	500
105.60	Anchorage Sand & Gravel	Both	3,180
<b>105.90</b>	<b>Team track, off Turnagain siding</b>	<b>N</b>	515
<b>106.40</b>	<b>MP 106.4 Crossover</b>	<b>N</b>	
106.56	Galco	S	750
106.81	<b>UNIVAR</b>	N	440
107.00	Alaska Metal Recycling	N	725
<b>107.20</b>	<b>MP 107.2 Crossover</b>	<b>S</b>	<b>4,586</b>
108.40	QAP	Both	1,760
<b>109.10</b>	<b>SSS Campbell Crossover</b>	<b>S</b>	
109.22	Alaska Welding	N	850
109.29	N.C.	N	1,000
109.37	Grocers' Wholesale/Air Liquide	N	1,000
<b>109.50</b>	<b>MP 109.5 Crossover</b>	<b>N</b>	
109.73	Wilder	N	2,750
109.73	<b>Alaska Steel, off Wilder track</b>	<b>N</b>	400

110.20	Anchorage International Airport Branch/ South Leg Airport Wye .....	S	
110.58	North Leg Airport Wye .....	N	
110.60	SBSTruss .....	S	537
113.90	South Yard Lead .....	S	

### 80.1.4 SIDING SWITCH LOCATIONS

<u>Siding</u>	<u>South Switch</u>	<u>North Switch</u>
Divide .....	11.80	12.30
Crown Point .....	24.40	25.20
Moose Pass .....	29.10	29.40
Hunter .....	39.20	40.20
Grandview .....	44.80	45.20
Tunnel .....	51.20	Spur
Spencer .....	55.10	55.80
Portage .....	63.80	64.35
Girdwood .....	74.50	74.90
Brookman .....	81.50	81.90
Indian .....	88.30	89.30
Rainbow .....	93.10	93.26
Potter .....	100.30	100.70
Turnagain .....	105.80	108.20
Campbell .....	109.10	110.70

### 80.1.5 MEASURED MILES

These mileposts are designated “measured miles” to check accuracy of locomotive speed indicators:

MP 5 to MP 6	MP 76 to MP 77
MP 38 to MP 39	MP 91 to MP 92
MP 57 to MP 58	MP 101 to MP 102

Advance Yard Limit signs are also “measured miles.”

### 80.2 EXCEPTED TRACK

#### EXCEPTED TRACK: SEWARD SUBDIVISION

The track, or segments of track, listed below is designated as excepted track as provided in Operating Rule 6.12.



DESCRIPTION

Spencer: Gravel Pit Tracks

**80.3 CALL-UP STATIONS**

Trains, as indicated, will call the applicable train dispatcher when the entire train has passed the last siding switch at the following locations:

- Hunter ..... All trains call district 1
- Portage ..... All trains call district 1

**80.4 SEWARD**

**Use row B on Determining Number of Hand Brakes to Apply Table to determine number of hand brakes to be secured at this location.**

Main track begins and ends at MP 2.9, Seward Subdivision. Movements over all tracks south of MP 2.9 will be made in compliance with Operating Rule 6.28.

**Do not park locomotive(s) with engine running by Alaska Votech Center.**

**Do not exceed walking speed on locomotive and car servicing tracks.**

Coach cleaning rack on south end of Round House Track 3 will not clear locomotive visors nor a person on side of equipment.

Freight trains should not be yarded in Track 8 and Upper 8 when it would interfere with a passenger train's ability to access the wye.

The two yard lights located on the east side of the north end of the yard are operated by separate manual on/off switches.

Train crews are to ensure that no cars or equipment are left on Upper 8 track between Jesse Lee switch and the crossover switch.

Exception to GCOR Rule 8.3: Airport switch MP 2.95 may be left lined and locked in either position. Switch target will display red when lined for the airport.

Shoreside Track is out of service from Shoreside Petroleum to end of track.

Jesse Lee Track 2 is out of service.

## **80.5 DIVIDE**

**Use row B on Determining Number of Hand Brakes to Apply Table to determine number of hand brakes to be secured at this location.**

## **80.6 CROWN POINT**

**Use row B on Determining Number of Hand Brakes to Apply Table to determine number of hand brakes to be secured at this location.**

Propane cars will be spotted at the unloading header located at north end of siding.

Close clearance at side ramp on siding.

The length of the siding south of the crossover switch is 2,253 feet.

The length of the siding north of the crossover derail is 1,200 feet. The crossover main line switch is north of the crossover on the siding.

A portable derail is in place on the Phillips spur at Crown Point.

SD70MAC locomotives prohibited between clearance points at south and north ends of siding.

## **80.7 MOOSE PASS**

**Use row B on Determining Number of Hand Brakes to Apply Table to determine number of hand brakes to be secured at this location.**

**Close clearance at side ramps on both sides of siding ramp track and east of siding.**

SD70MAC locomotives prohibited between clearance points at south and north ends of siding.

## **80.8 HUNTER**

**Use row B on Determining Number of Hand Brakes to Apply Table to determine number of hand brakes to be secured at this location.**

**Hunter wye out of service unless authorized to occupy track by engineering supervisor.**

**SD70MAC locomotives prohibited from the wye.**

## **80.9 GRANDVIEW**

**Use row C on Determining Number of Hand Brakes to Apply Table to determine number of hand brakes to be secured at this location.**

Cars left at Grandview must have sufficient hand brakes set on each end of cut to safely secure cars. **When necessary**, rail clamps will be placed on downhill end of cars set out. Crews picking up cars must remove rail clamp. When rail clamps are not in use, they must be returned, chained, and secured by switch lock to switch stand.

Capacity of siding is 2,180 feet from south switch clearance point to derail on north end of siding.

## **80.10 DOUBLING GRANDVIEW HILL**

All Southward trains exceeding 4,000 feet in length must double Grandview Hill, unless otherwise directed.

## **80.11 MP 50**

Milepost 50 removed due to line change. The distance between MP 49 and MP 51 is approximately 7,241 feet.

## **80.12 TUNNEL**

**Use row D on Determining Number of Hand Brakes to Apply Table to determine number of hand brakes to be secured at this location.**

**When necessary**, rail clamps will be placed on north end of cars set out. Crews picking up cars must remove rail clamp. When rail clamps are not in use, they must be returned, chained, and secured by switch lock to switch stand.

SD70MAC locomotives prohibited beyond clearance point of siding.

## **80.13 SPENCER**

**Use row B on Determining Number of Hand Brakes to Apply Table to determine number of hand brakes to be secured at this location.**

**Spencer Pit Track MP 55.82 out of service unless authorized to occupy track by engineering supervisor.**

Do not exceed walking speed on any tracks at Spencer Pit Track MP 55.82.

SD70MAC locomotives prohibited between clearance points at south and north ends of siding.

SD70MAC locomotives prohibited from clearance point to **end of all pit tracks.**

### **80.14 MP 62.8 SNOW FLEET TRACK**

**Use row B on Determining Number of Hand Brakes to Apply Table to determine number of hand brakes to be secured at this location.**

SD70MAC locomotives prohibited from clearance point to end of track.

### **80.15 PORTAGE**

**Use row B on Determining Number of Hand Brakes to Apply Chart to determine number of hand brakes to be secured at this location.**

Seward Subdivision Special Instructions govern Portage on the Seward Subdivision. Whittier Subdivision Special Instructions govern Portage on the Whittier Subdivision.

The normal position for the Portage junction switch, MP 64.3, is for the Seward Main Track and it must be lined and locked in that position, unless authorized by track warrant to leave switch in reverse position. The switch target is illuminated, and will indicate green when lined for movement on the Seward Subdivision, and will indicate red when lined for movement to Whittier Subdivision.

**Side ramp track (Old Shuttle Track) is the designated siding.**

Side ramp at siding is 65 feet long and is close clearance.

SD70MAC locomotives prohibited between south end of ramp and south clearance point of **side ramp track.**

## **80.16 GIRDWOOD**

**Use row B on Determining Number of Hand Brakes to Apply Chart to determine number of hand brakes to be secured at this location.**

SD70MAC locomotives prohibited between clearance points at south and north ends of siding.

## **80.17 BROOKMAN**

**Use row B on Determining Number of Hand Brakes to Apply Chart to determine number of hand brakes to be secured at this location.**

SD70MAC locomotives prohibited between clearance points at south and north ends of siding.

## **80.18 INDIAN**

**Use row A on Determining Number of Hand Brakes to Apply Chart to determine number of hand brakes to be secured at this location.**

## **80.19 RAINBOW**

**Use row B on Determining Number of Hand Brakes to Apply Chart to determine number of hand brakes to be secured at this location.**

SD70MAC locomotives prohibited between clearance point and end of track.

## **80.20 POTTER**

**Use row B on Determining Number of Hand Brakes to Apply Chart to determine number of hand brakes to be secured at this location.**

Northward trains will contact the Terminal Superintendent's office for yarding instructions in Anchorage Yard. If unable to contact the Terminal Superintendent, contact the Train Dispatcher.

SD70MAC locomotives prohibited between clearance points at south and north ends of siding.

Anchorage Natural Gas **access must** not to be blocked with standing cars.

### **80.21 TURNAGAIN**

**Use row B on Determining Number of Hand Brakes to Apply Chart to determine number of hand brakes to be secured at this location.**

**Locomotives and equipment must not stop or be left standing with engine running between MP 107.7 and MP 108.2 from 22:00 until 06:00.**

Southward movements over Anchorage Sand and Gravel track at Klatt Road will not activate automatic crossing signal until train or engine is within thirty (30) feet of crossing.

### **80.22 QAP MP 108.4**

**Use row B on Determining Number of Hand Brakes to Apply Chart to determine number of hand brakes to be secured at this location.**

Do not exceed walking speed over dump pit.

### **80.23 CAMPBELL**

**Use row B on Determining Number of Hand Brakes to Apply Chart to determine number of hand brakes to be secured at this location.**

### **80.24 CP 1139 (OVL)**

**CTC limits are in effect at CP 1139 (Switch MP 113.9).**

### **80.25 ANCHORAGE**

Anchorage Subdivision Special Instructions will govern Anchorage Yard.

**80.26 ANCHORAGE INTERNATIONAL AIRPORT BRANCH**

SOUTH ↓		<b>Auxiliary Track</b>		↑ NORTH	
Call Code	Capacity of siding	STATIONS	Mile Post	Meth. of Opr.	Detector Locations
		End of Track	J 2.45	6.28	
00		Airport Branch Jct <small>JY</small>	J 0.0		

**80.26.1 METHOD OF OPERATION**

LOCATION	METHOD
MP J 0.00 - MP J 2.45	GCOR Rule 6.28

**80.26.2 MAXIMUM AUTHORIZED SPEEDS**

Maximum Authorized Speed Between:		In MPH For:
		Frt Psgr
MP J 0.00 and MP J 1.23 .....	25	25
MP J 1.23 and MP J 2.45 .....	15	15

**80.26.3 LOCATION OF OTHER TRACKS**

MP	Switch Location	Capacity in Feet
J 0.35	Anchorage School District .....	N 970
J 1.60	Airport Runaround .....	Both 744
J 2.33	Terminal Track .....	S 520

**80.26.4 AIRPORT BRANCH JUNCTION, MP J 0.0**

The Airport Branch Junction/South Leg Airport Wye Switch, MP J 0.0/MP 110.2, is the beginning of the Anchorage International Airport Branch.

**80.26.5 ANCHORAGE INTERNATIONAL  
AIRPORT TERMINAL, MP J 2.45**

Close clearance at terminal platform located between end of Anchorage International Airport Branch and Terminal Track.

**80.27 SEWARD SUBDIVISION GRADE  
PROFILE**



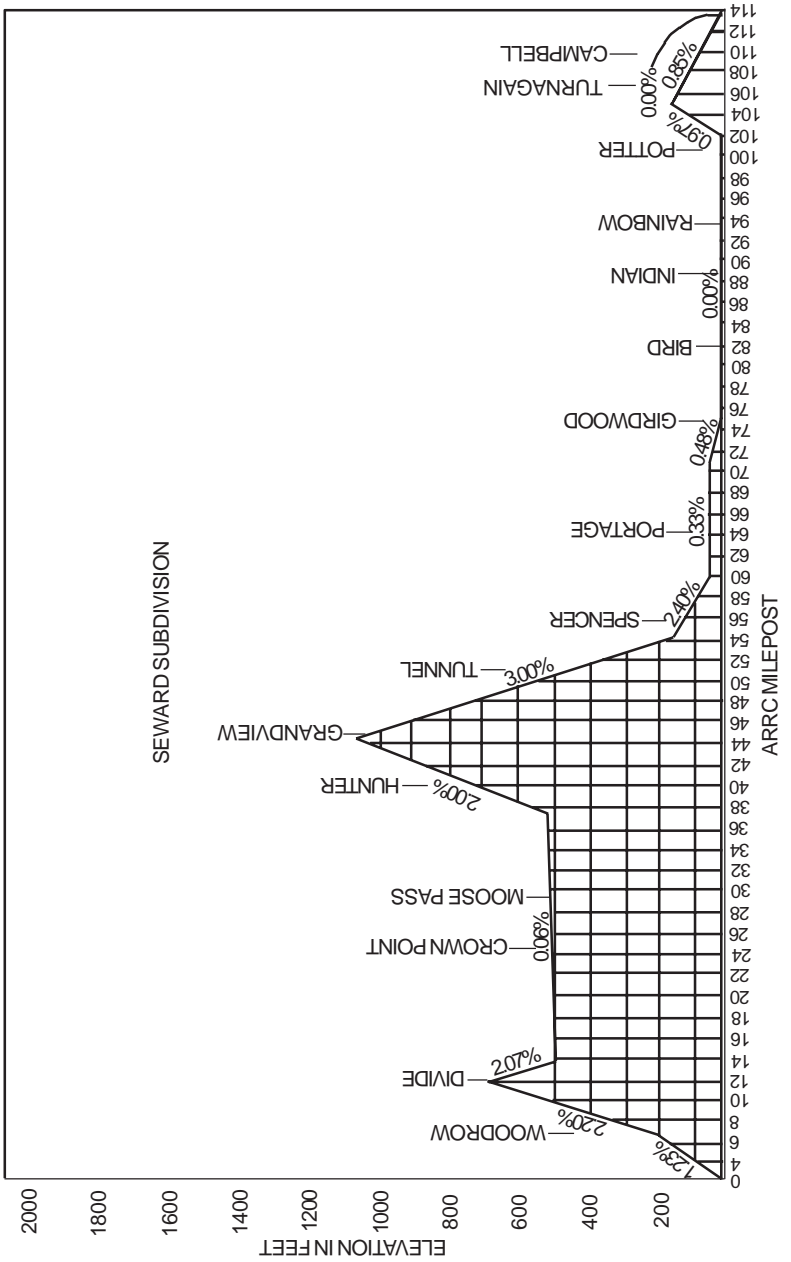

*Think twice,  
once for the other  
guy.*

**81.0 WHITTIER SUBDIVISION****81.1 WHITTIER SUBDIVISION**

SOUTH ↓		Main Track			↑ NORTH	
Call Code	Capacity of siding	STATIONS		Mile Post	Meth. of Opr.	Detector Locations
04		Portage 6.5	JXY	F 12.0	YL	
	2,340	Bear Valley 5.5		F 5.5	TWC	
03		Whittier	BWX	F 0.0	CTC	
					YL	

**81.1.1 METHOD OF OPERATION**

LOCATION	METHOD OF OPERATION
MP F 0.0 - MP F 2.5	YL
MP F 2.5 - MP F 5.2	CTC
MP F 5.2 - MP F10.8	TWC
MP F10.8 - MP F12.0	YL

**81.1.2 MAXIMUM AUTHORIZED SPEEDS**

Maximum Authorized Speed Between:	In MPH For:	
	Frt	Psg
MP F 0.00 and MP F 1.30 (Yard Limit) .....	10	10
MP F 1.30 and MP F 2.50 (Yard Limit) .....	20	20
MP F 2.50 and MP F 5.20 Northward .....	20	20
MP F 2.50 and MP F 5.20 Southward .....	25	25
MP F 5.20 and MP F 6.90 .....	25	25
MP F 6.90 and MP F 10.80 .....	49	49
MP F 10.80 and MP F 12.00 (Yard Limit) .....	20	20

**81.1.3 LOCATION OF OTHER TRACKS**

MP	Name	Switch Location	Capacity in feet
F 11.3	New Yard Track 1 .....	Both	4,240
F 11.3	New Yard Track 2 .....	Both	3,960
F 11.3	New Yard Track 3 .....	Both	3,785
F 11.3	New Yard Track 4 .....	Both	3,585

**81.1.4 SIDING SWITCH LOCATION**

Siding	North Switch	South Switch
Bear Valley .....	F5.3	F5.7

**81.1.5 MEASURED MILE**

These mileposts are designated “measured miles” to check accuracy of locomotive speed indicators:

MP F 8 to MP F 9

Advance Yard Limit signs are also “measured miles.”

**81.2 LOCATION OF TUNNEL DOORS**

MP	Name
F 2.54	Whittier Tunnel - Door 1
F 5.18	Whittier Tunnel - Door 2
F 5.73	Portage Tunnel - Door 3
F 6.91	Portage Tunnel - Door 4

**81.3 EXCEPTED TRACK**

The track, or segments of track, listed below is designated as excepted track as provided in Operating Rule 6.12.

DESCRIPTION

Sawmill Track and Ramp Storage Spur, Whittier

## 81.4 WHITTIER

**Use row B on Determining Number of Hand Brakes to Apply Table to determine number of hand brakes to be secured at this location.**

Radio channel 5 (primary) or 6 (secondary) will be used during barge switching operation.

**The U.S. Coast Guard Regulations require waterfront port facilities to be designated “NO SMOKING” areas where dangerous cargo is handled, stored, stowed, loaded, discharged, or transported. In accordance with these regulations, the ARRC Port of Whittier (the area from the Assistant Terminal Superintendent’s office road crossing to the bay) is designated a “NO SMOKING” area. The only area within the port facility authorized as a smoking area is the Crowley Marine break shack.**

When switching movements are being made over the slip at Whittier, the following procedures apply:

- Cars will not be placed on the slip unless ramp is at rest on barge.
- Brake pipe air must be cut in on all cars.
- Movement is to be controlled with independent air brakes only and automatic brakes are not to be used except in case of emergency.
- Engines used in switching service for barge operations will not be permitted on ramp while switching.
- Employees are prohibited from riding on outboard side of car while car is on outboard track of barge slip.
- All movements on and off rail barges will be made **not exceeding** 3 MPH, prepared to stop at any time.
- A safety stop will be made 1 car length prior to making any joints on the slip or barge.
- Bunching cars on barges is only to be done after a joint or a stop has been made.
- During loading and unloading of “break bulk” cargo, flat cars may be moved with unsecured loads.

All movements on and off barges will be made within designated slip-angle limitations.

## Whittier Subdivision Special Instructions

---

The following car-handling limitations for movements on and off rail barges will apply (exclusive of handle):

1 locomotive ----- 15 cars  
2 or more locomotives ----- 21 cars

Note: SD70MAC locomotives must not be used to switch barge.

When movements are made south of the slip crossing and the slip is in a raised position, the following will apply:

- A safety stop must be made north of the crossing before proceeding southward.
- Crew member must precede the leading car of the movement.
- Movement will be made at walking speed.
- Each piece of equipment left south of the crossing must be secured by its hand brake.

Whittier slip derail must be in derail position except during switching.

**Sawmill Track out of service unless authorized to occupy track by engineering supervisor.**

The target on the switch into Old Shuttle Runaround track when lined for Old Shuttle Runaround track will indicate green.

Yard lights can be turned on remotely by radio. To turn them on, a radio equipped with a dial touch pad must be used and tuned to channel 4. Then key-in numbers 61, 62, 63, 64, and 65. These lights will automatically turn off after approximately four hours. To re-illuminate them, wait at least two minutes after they have extinguished, then repeat the steps outlined above.

### 81.5 WHITTIER SUBDIVISION TUNNELS

Portage Tunnel Doors:

A signal in the form of a switch target is provided for Portage Tunnel doors. This signal will display indication only for the door where it is located. These signals are located to the right of the track, in the direction of approach, in front of the entrance of the tunnel. These signals will display a red aspect when the doors may be closed, and will display a green aspect when doors are opened on each end of tunnel. Normally, doors will be open during the period April 16 through October 31, and closed during the period November 1 through April 15.

If the target displays a red aspect, the train must stop before entering the tunnel, and may proceed only on the authority of the foreman in charge, or the train dispatcher (after ensuring both tunnel doors are open).

<u>LOCATION</u>	<u>DIRECTION</u>
Door 3 - MP F 5.73 - Portage Tunnel .....	Northward
Door 4 - MP F 6.91 - Portage Tunnel .....	Southward

Under no circumstances will a train, other than a company work train under the direction of an Engineering Supervisor, be allowed to enter the tunnel until both doors have been opened. After a train has entered the tunnel, the door must not be closed until after the train has cleared the opposite end of the tunnel.

During the period doors are closed, conductors of trains en route to or from Whittier will contact the Train Dispatcher, via radio, who will arrange to have Portage Tunnel doors opened approximately one hour prior to expected arrival at Door 4.

## **81.6 EMERGENCY TELEPHONES IN WHITTIER SUBDIVISION TUNNELS**

Emergency telephones may be used to provide access to Anchorage emergency services by dialing 9-911, to call the Train Dispatcher by dialing 2504, or to call Anchorage local phone service by dialing 9 and the desired telephone number. The telephones are located inside the Portage Tunnel portals at Doors 3 and 4. The number of these phones and the tunnel control operator is 2306.

Whittier Tunnel Signal System emergency phones are located approximately every 300 feet within the tunnel. These phones are connected to the tunnel operator's work station which is normally only occupied while the tunnel control center is in operation. When used while tunnel control center is closed, the call will be routed to Alaska General Alarm.

## **81.7 WHITTIER TUNNEL SIGNAL SYSTEM (TSS)**

**CTC limits are in effect on main track between MP F 2.5 and MP F 5.2.**

The telephone number to the tunnel control center is 265-2306; this number also rings at the telephones at doors 2, 3 and 4.

### **81.7.1 TRAIN MOVEMENTS**

Trains approaching CTC limits must attempt to notify the tunnel control center, when open, either by radio or by telephone at 265-2306, fifteen minutes prior to arrival at applicable absolute signal.

### **81.7.2 ON-TRACK MOVEMENTS**

To perform maintenance on or foul the main track inside the tunnel, on-track vehicles must request track and time from the train dispatcher, and must inform the dispatcher of what movements will be made.

If Tunnel Control Center is in operation, the train dispatcher will coordinate movements with the tunnel control operator.

If the tunnel control center is not in operation, use maintenance roads located at each end of the control point. Entry to the maintenance road is through swing gates secured with 05 locks. These gates must be re-secured after passage. If access to the maintenance road is blocked contact the train dispatcher for further instructions.

Portal door control buttons are located at the traffic islands in locked boxes secured with 05 locks, but are only functional when track and time authority is in effect. These buttons open or close both portal doors. Telephones located in these boxes connect directly to the train dispatcher.

After track and time authority is obtained, use the control button at the traffic island to open both portal doors.

Control buttons to close each portal door are located just inside each portal. Each door must be closed after passage: the entering door at the portal, the leaving door either at the portal or from the traffic island. However, whenever the door open control button at a traffic island is used to open the portal doors, the door close control button at a traffic island must be pressed, even if the doors were closed at the portals.



**Release track and time authority to the train dispatcher when movement is clear of the control point.**

**Known maintenance within or on the Whittier Tunnel control point to be performed while the tunnel control center is in operation, must be scheduled at least 48 hours in advance through the Chief Dispatcher at 265-2421.**

### **81.7.3 FOUL TIME**

**Employees may request Foul Time to perform maintenance on or foul the main track outside the tunnel between the portal and the absolute signal when the Tunnel Control Center is in operation. Work performed under foul time authority must not interfere with highway traffic unless movement is coordinated with the tunnel control operator.**

### **81.7.4 SWITCH POINT DERAILS**

**Switch point derails are located at the absolute signals at MP F 2.5 and MP F 5.2. The length of the tracks off these derails is approximately 200 feet.**

**On-track vehicles must:**

- **before moving over switch point derails, make sure they are properly lined for intended route.**
- **not exceed 10 MPH over switch point derails.**
- **if applicable, not return switch point derail to power until entire movement is clear of the switch.**

### **81.7.5 HIGHWAY VEHICLE CROSSING GATES**

**Vehicle crossing gates MUST NOT be lifted to gain access to the Whittier Tunnel unless authorized by train dispatcher. Lifting the gates while the control point is lined for main track movements locks up the signal system, preventing movement of both rail and highway traffic, and it has to be reset by both a signal maintainer and a tunnel control operator.**

## **81.7.6 WHITTIER TUNNEL SIGNAL SYSTEM MALFUNCTION**

During a malfunction of the signal system, the tunnel control operator is unable to control the exhaust fans. Consequently, public vehicles must not enter the control point until a signal maintainer has repaired the control point and the exhaust fans are operational.

## **81.8 BEAR VALLEY**

**Use row A on Determining Number of Hand Brakes to Apply Table to determine number of hand brakes to be secured at this location.**

## **81.9 PORTAGE**

**Use row A on Determining Number of Hand Brakes to Apply Table to determine number of hand brakes to be secured at this location.**

Whittier Subdivision begins and ends at tail of wye switch, MP F 12. Movement between tail of wye switch and Portage junction switch, MP F 12.4 (MP 64.3 on Seward Subdivision), is on the north leg of wye, an auxiliary track. Do not exceed 16 MPH on north leg of wye. Instructions to restore junction switch, MP 12.4, or leave reversed, will be included in the track warrant authorizing movement to or from this switch on the Seward Subdivision.

**New Yard Track 1 out of service unless authorized to occupy track by engineering supervisor.**

## **81.10 WHITTIER SUBDIVISION GRADE PROFILE**

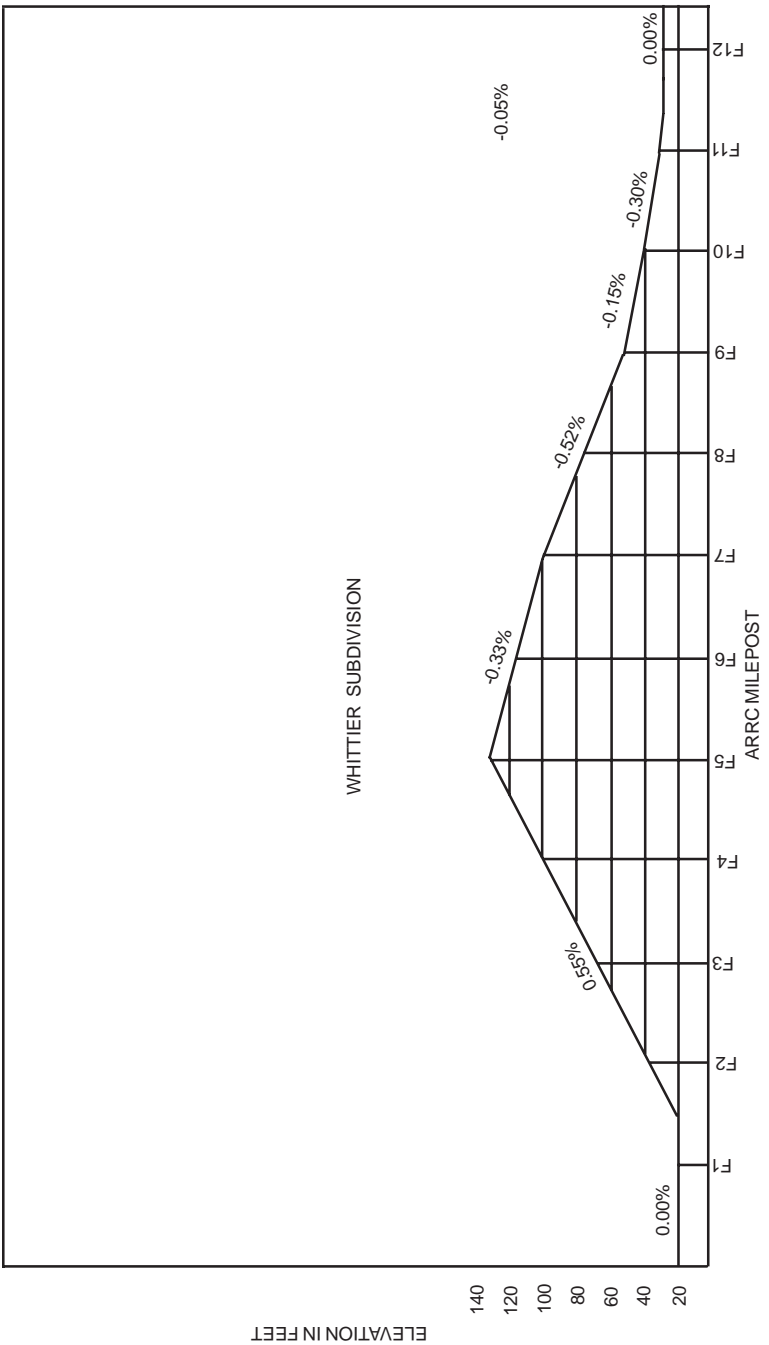

***Accident prevention  
should be your #1  
intention.***

# 82.0 ANCHORAGE SUBDIVISION

## 82.1 ANCHORAGE SUBDIVISION

**SOUTH** ↓ **Main Track** ↑ **NORTH**

Call Code	Capacity of siding	STATIONS	Mile Post	Meth. of Opr.	Detector Locations	
	<b>5,342</b>	Honolulu 7.3	288.7	TWC	290.5 A	
05	<b>6,026</b>	Hurricane 7.6	c 281.4	CTC	281.5 B	
	<b>2,108</b>	Chulitna 5.4	Y 273.8	TWC		
	<b>2,132 N</b>	Canyon 5.2	268.4			
04	<b>5,274</b>	Gold Creek 5.5	c 263.2			
	<b>1,470</b>	Sherman 6.7	257.7			
	<b>6,755</b>	<b>Susitna</b> 9.2	<b>251.0</b>			
	<b>3,016 S</b>	Curry 12.3	Y 248.5			
	<b>6,266</b>	Chase 9.5	236.2			
03	<b>1,750 N</b>	Talkeetna 11.4	c 226.7			225.7 B
	<b>6,011</b>	Sunshine 6.0	215.3			
	<b>4,143</b>	Montana 7.0	209.3			
	<b>1,328</b>	Caswell 8.4	202.3		206.2 B	
	<b>1,607</b>	Kashwitna 8.2	193.9			
06	<b>6,288</b>	Willow 10.4	cy 185.7		185.2 C	
01	<b>2,422</b>	Houston 9.7	175.3			
	<b>6,229</b>	Pittman 5.8	165.6	CTC		
02	<b>3,214</b>	Wasilla 8.8	159.8	TWC	164.3 B	
	<b>WYE</b>	Palmer Junction 0.3	cJY 151.0	CTC		
	<b>1,320 N</b>	Matanuska 8.9	150.7	TWC		
	<b>5,452</b>	Eklutna 5.5	141.8		145.5 B	
	<b>4,895</b>	Birchwood 8.3	136.3			
	<b>5,867</b>	Reves 13.7	128.0	CTC	123.0 B	
00		Anchorage BWXYZ	114.3	TWC 2 MT CTC TWC YL		

## ANCHORAGE SUBDIVISION

(Continued)

**SOUTH**    **↓**    **Main Track**    **↑**    **NORTH**

Call    Capacity    **STATIONS**    Mile    Meth.    Detector  
Code    of siding          Post    of Opr.    Locations

03		Fairbanks <small>7.3</small>	BJLWXZ	470.3	YL	
	<b>718 N</b>	Happy <small>6.8</small>		463.0		
	<b>762 N</b>	Dome <small>5.4</small>		456.2		456.2 B
	<b>4,178</b>	Saulich <small>11.3</small>		450.8		
	<b>2,061 S</b>	Standard <small>7.9</small>		439.5		
	<b>3,708</b>	Dunbar <small>11.2</small>		431.6		
	<b>3,861</b>	Manley <small>5.0</small>		420.4		417.7 B
02	<b>4,156</b>	North Nenana <small>3.7</small>		415.4		
	<b>3,198</b>	Nenana <small>20.6</small>	C	411.7		405.0 C
	<b>4,095</b>	Clear Site <small>11.7</small>	Y	392.9		
	<b>993</b>	Browne <small>10.0</small>		381.2		
	<b>6,200</b>	Bear Creek <small>6.6</small>		374.6		
	<b>975</b>	Ferry <small>8.9</small>		371.2		370.4 B
	<b>8,417</b>	Usibelli Tipple <small>3.6</small>		362.3	TWC	
00	<b>5,886</b>	Healy <small>3.0</small>	BCJWY	358.7		356.5 A
	<b>745</b>	Garner <small>8.0</small>		355.7		353.1 A
	<b>2,619</b>	Denali Park <small>5.0</small>		347.7		350.4 A
	<b>6,200</b>	Oliver <small>8.3</small>		342.7		348.2 B
	<b>2,180</b>	Carlo <small>7.7</small>		334.4		
	<b>5,375</b>	Windy <small>7.2</small>		326.7		
06	<b>1,777</b>	Cantwell <small>7.0</small>	C	319.5		319.4 C
	<b>2,975</b>	Summit <small>8.2</small>		312.5		
	<b>4,135</b>	Broad Pass <small>7.2</small>	Y	304.3		
	<b>4,190</b>	Colorado		297.1		

**82.1.1 METHOD OF OPERATION**

LOCATION	METHOD OF OPERATION
MP 114.30 - MP 115.50	YL
MP 115.50 - MP 117.00	TWC
MP 117.00 - MP 119.80	2 MT CTC
MP 119.80 - MP 128.00	TWC
MP 128.00 - MP 129.20	CTC
MP 129.20 - MP 150.45	TWC
MP 150.45 - MP 150.50	CTC
MP 150.50 - MP 164.95	TWC
MP 164.95 - MP 166.25	CTC
MP 166.25 - MP 281.20	TWC
MP 281.20 - MP 282.40	CTC
MP 282.40 - MP 467.50	TWC
MP 467.50 - MP 470.30	YL

**82.1.2 MAXIMUM AUTHORIZED SPEEDS**

Maximum Authorized Speed Between:	In MPH For:	
	Frt	Psgr
MP 114.30 and MP 115.10 (Yard Limit) .....	10	20
MP 115.10 and MP 115.50 (Yard Limit) .....	20	20
MP 115.50 and MP 117.00 .....	<b>30</b>	<b>30</b>
<b>MP 117.00 and MP 117.60 East Main Track</b> .....	<b>30</b>	<b>30</b>
<b>MP 117.60 and MP 119.80 East Main Track</b> .....	<b>40</b>	<b>40</b>
<b>MP 117.00 and MP 119.80 West Main Track</b> .....	<b>25</b>	<b>25</b>
MP 119.80 and MP 121.50 .....	<b>40</b>	<b>40</b>
<b>MP 121.50 and MP 126.40</b> .....	25	25
MP 126.40 and MP 139.50 .....	35	35

# Anchorage Subdivision Special Instructions

MP 139.50 and MP 146.00	45	45
MP 146.00 and MP 146.60	30	30
MP 146.60 and MP 150.87	45	45
MP 150.87 and MP 151.15	30	30
MP 151.15 and MP 152.10	45	45
MP 152.10 and MP 153.70	35	35
MP 153.70 and MP 159.60	25	25
MP 159.60 and MP 159.90	49	49
<b>MP 159.90 and MP 159.90 Northward HER</b>	<b>25</b>	<b>25</b>
MP 159.90 and MP 183.57	40	40
MP 183.57 and MP 193.20	49	49
MP 193.20 and MP 193.40	45	45
MP 193.40 and MP 211.25	49	49
MP 211.25 and MP 213.51	40	40
MP 213.51 and MP 224.50	49	49
MP 224.50 and MP 224.90	40	40
MP 224.90 and MP 226.00	49	49
MP 226.00 and MP 227.70	40	40
MP 227.70 and MP 239.70	49	49
MP 239.70 and MP 243.05	35	35
MP 243.05 and MP 248.80	30	30
MP 248.80 and MP 255.00	40	40
MP 255.00 and MP 258.00	35	35
MP 258.00 and MP 261.00	30	30
MP 261.00 and MP 266.00	40	40
MP 266.00 and MP 266.50	35	35
MP 266.50 and MP 266.90	25	25
MP 266.90 and MP 269.20	35	35
MP 269.20 and MP 270.30	20	20
MP 270.30 and MP 277.15	30	30
MP 277.15 and MP 278.50	25	25
MP 278.50 and MP 283.95	35	35
MP 283.95 and MP 284.27	10	10
MP 284.27 and MP 288.30	25	25
MP 288.30 and MP 292.25	45	45
MP 292.25 and MP 294.50	30	30
MP 294.50 and MP 303.50	49	49
MP 303.50 and MP 320.00	45	45
MP 320.00 and MP 321.45	35	35
MP 321.45 and MP 322.25	25	25
MP 322.25 and MP 327.01	30	30
MP 327.01 and MP 327.80	25	25
MP 327.80 and MP 331.50	30	30
MP 331.50 and MP 332.80	25	25
MP 332.80 and MP 339.70	30	30
MP 339.70 and MP 341.70	25	25
MP 341.70 and MP 347.10	30	30
MP 347.10 and MP 347.50	10	10
MP 347.50 and MP 357.50	15	15
MP 357.50 and MP 358.30	20	20
MP 358.30 and MP 361.15	35	35



## Anchorage Subdivision Special Instructions

MP 361.15	and MP 378.90		49	49
MP 378.90	and MP 379.50		35	35
MP 379.50	and MP 385.60		40	40
MP 385.60	and MP 411.10		49	49
MP 411.10	and MP 411.65		20	20
MP 411.65	and MP 415.10		25	25
MP 415.10	and MP 416.00		40	40
MP 416.00	and MP 431.80		49	49
MP 431.80	and MP 452.85		40	40
MP 452.85	and MP 463.10		30	30
MP 463.10	and MP 467.50		40	40
MP 467.50	and MP 469.90 (Yard Limit)		20	20
MP 469.90	and MP 470.30 (Yard Limit)		8	8

### 82.1.3 SIDING SWITCH LOCATIONS

	South Switch	North Switch
<b>Siding</b>		
Reves .....	128.00	129.20
Birchwood .....	135.20	136.30
Eklutna .....	141.00	142.10
Matanuska .....	Spur	150.90
Palmer Junction .....	150.50	151.10
Wasilla .....	159.40	160.30
Pittman .....	164.95	166.25
Houston .....	175.10	175.60
Willow .....	185.20	186.50
Kashwitna .....	193.50	194.00
Caswell .....	201.90	202.40
Montana .....	208.50	209.50
Sunshine .....	214.50	215.60
223 Pit .....	223.10	223.60
Talkeetna .....	Spur	227.10
Chase .....	235.30	236.40
Curry .....	247.80	Spur
Susitna .....	250.20	251.60
Sherman .....	257.40	257.80
Gold Creek .....	262.30	263.50
Canyon .....	Spur	288.60
Chulitna .....	273.60	274.10
Hurricane .....	281.20	282.40
Honolulu .....	288.30	289.50
Colorado .....	296.60	297.50
Broad Pass .....	303.50	304.50

## Anchorage Subdivision Special Instructions

Summit .....	312.15	312.80
Cantwell .....	319.30	319.70
Windy .....	325.70	326.90
Carlo .....	334.30	334.70
Oliver .....	341.70	342.90
Denali Park .....	347.50	348.10
Garner .....	355.70	355.90
Healy .....	358.90	359.90
Usibelli Tipple .....	361.70	363.00
Ferry .....	371.10	371.50
Bear Creek .....	374.00	375.23
Browne .....	381.10	381.40
388 Pit .....	388.10	388.40
Clear Site .....	392.10	392.90
Nenana .....	411.90	412.70
North Nenana .....	415.20	416.00
Manley .....	420.40	421.30
Dunbar .....	430.90	431.80
Standard .....	439.10	Spur
Saulich .....	450.40	451.00
Dome .....	Spur	456.20
Happy .....	Spur	463.10

### 82.1.4 LOCATION OF OTHER TRACKS

MP	Switch Location	Capacity in Feet
115.4	Yard Lead .....	<b>S 8,264</b>
117.0	<b>MP 117 XO / CP 1170</b> .....	<b>N</b>
120.0	Fort Richardson .....	S
131.0	Powder Spur .....	S 2,896
136.3	Birchwood Track 2 .....	Both 4,446
136.3	Birchwood Track 3 .....	N 4,283
142.0	Rock Pit .....	N 2,936
142.0	Ramp, off Rock Pit track .....	N <b>856</b>
<b>145.45</b>	<b>MP 145.45 Spur</b> .....	<b>N 200</b>
<b>147.55</b>	<b>MP 147.55 Spur</b> .....	<b>S</b>
158.7	<b>Spenard Builders Supply</b> .....	S 457
159.8	Short Siding, off Wasilla Siding .....	Both 204
161.6	Spenard Builders Supply .....	Both 675
223.6	Log Track .....	Both 2,200

## Anchorage Subdivision Special Instructions

223.6	Pit Track off Log Track .....	N	2,575
226.7	House Track .....	Both	1,060
226.7	Ramp, off House Track .....	S	195
263.2	Carr Outfit Track, off Gold Creek Siding .....	N	1,735
281.5	Engineering Track, off Hurricane Siding .....	N	940
319.5	Ramp, off Cantwell Siding .....	N	290
326.7	Outfit Track, off Windy Siding .....	S	1,252
333.7	House Track .....	N	330
350.6	Cascade Outfit Track .....	N	743
358.7	East 1 .....	Both	3,157
358.7	East 2 .....	Both	2,363
358.7	East 3, off East 2 .....	S	1,283
358.7	Old Rip Track .....	N	428
358.7	Roundhouse 1 .....	N	452
358.7	Roundhouse 2 .....	N	277
358.7	Crane Track .....	N	143
358.7	New Rip Track .....	N	355
359.0	UCM Prill Track .....	Both	1,300
359.0	West 1 .....	Both	5,834
359.0	West 2 .....	Both	5,693
359.0	Outfit Track .....	S	1,085
359.0	Ramp Track .....	S	165
360.0	New Storage .....	N	3,890
362.6	Outfit Track (Lignite) .....	N	1,025
371.2	Ramp, off Ferry Siding .....	S	155
388.0	388 Pit -Tail of Wye .....	Both	3,465
392.2	Old Clear .....	N	5,021
392.9	Main Base, off Tail of Wye .....	Both	
392.9	Short Siding .....	Both	789
401.1	<b>Maintenance Track</b> .....	S	156
411.1	Engineering Spur .....	S	440
411.1	Track 1, Lower Yard .....	S	1,100
411.1	Track 2, Lower Yard .....	S	1,032
411.1	Track 3, Lower Yard .....	Both	700
411.1	New Ramp, off Track 3, Lower Yard .....	S	397
411.1	Old Ramp, off Track 3, Lower Yard .....	S	509
411.1	Hi-line, off Track 3, Lower Yard .....	S	500
411.3	Waterfront Track .....	Both	3,300
411.8	House Track, off Waterfront Track .....	N	1,240
412.0	Long Siding .....	Both	3,198
412.0	Union Oil Spur, off Long Siding .....	N	655
<b>415.4</b>	<b>Spur, off North Nenana Siding</b> .....	<b>S</b>	<b>363</b>
<b>420.4</b>	<b>Spur, off Manley Siding</b> .....	<b>N</b>	<b>240</b>
432.6	Outfit Track .....	N	202
467.0	UAF .....	Both	3,250

## 82.1.5 MEASURED MILES

These mileposts are designated “measured miles” to check accuracy of locomotive speed indicators:

MP 118 to MP 119	MP 306 to MP 307
MP 119 to MP 120	MP 344 to MP 345
MP 143 to MP 144	MP 368 to MP 369
MP 165 to MP 166	MP 391 to MP 392
MP 192 to MP 193	MP 406 to MP 407
MP 219 to MP 220	MP 418 to MP 419
MP 230 to MP 231	MP 433 to MP 434
MP 272 to MP 273	MP 464 to MP 465
MP 290 to MP 291	

Advance Yard Limit signs are also “measured miles.”

## 82.2 EXCEPTED TRACK

### EXCEPTED TRACK: ANCHORAGE SUBDIVISION

The track, or segments of track, listed below is designated as excepted track as provided in Operating Rule 6.12.

#### DESCRIPTION

Powder Spur, MP 131  
Ramp Track and Rock Pit Track, MP 142  
Gravel Pit Track and Log Track, Mile 223.6  
Ramp Track, Cantwell  
Outfit Track, Windy  
Ramp Track, Denali Park  
Outfit Track, Mile 350.6  
Outfit Track, East 3, Old Rip and Rip Track and Roundhouse Track 1 and 2 at Healy  
Suntrana Branch  
Ramp Track, Ferry  
Gravel Pit Track, Outfit Track and Wye, MP 388  
Wye and Main Base, Clear Site  
Old Clear  
**Maintenance Track, MP 401.1**  
Ramp Track, Nenana

## 82.3 CALL-UP STATIONS

Trains, as indicated, will call the **applicable district train dispatcher** when the entire train has passed the last siding switch at the following locations:

Palmer Junction .....	<b>Southward trains call district 1</b> <b>Northward trains call district 2</b>
Willow .....	<b>Southward trains call district 1</b> <b>Northward trains call district 2</b>
Talkeetna .....	<b>All trains call district 2</b>
Gold Creek .....	<b>All trains call district 2</b>
Hurricane .....	<b>All trains call district 2</b>
Cantwell .....	<b>All trains call district 2</b>
Healy .....	<b>All trains call district 2</b>
Nenana .....	<b>Northward trains call district 2</b>
Manley .....	<b>Southward trains call district 2</b>

## 82.4 ANCHORAGE

Use row B on Determining Number of Hand Brakes to Apply Table to determine number of hand brakes to be secured at this location.

If unable to contact the assistant terminal superintendent or operations support technician, each train, engine, track car or employee working on or near a track will announce its intention to move within, or enter into, the yard limit territories.

Trains departing the Anchorage terminal, which required a class 1 initial terminal air brake test before departure, must be given a roll-by inspection by a qualified employee.

CTC limits are in effect at CP 1139 (Switch MP 113.9).

CTC limits are in effect on East Main Track and West Main Track between CP 1170 (MP 117 XO) and CP 1198 (Switch MP 119.8). A drill signal may be requested from the dispatcher for switching movements on the West Main Track north of CP 1170. Notify the dispatcher when the drill signal is no longer required.

### North Yard Lead, MP 116.5, Power Switch Operation:

The illuminated switch target provides the following information:

**Green:** Switch points fit properly in normal position.

**Yellow: Switch points fit properly in reverse position.**

In addition, the lights flash alternately yellow and green when the switch is in transition between normal and reverse positions, or if the switch fails to complete the throw to the full normal or reverse position. If the lights are flashing, the switch must be operated by hand to the desired position, and the switch points checked to ensure they are in the proper position. Any malfunction of this switch or electronic switch target must immediately be reported to the assistant terminal superintendent on duty.

The switch can be operated in one of three ways:

**1) REMOTE CONTROL OPERATION:**

The presence detection loops must not be occupied by a car or locomotive. These loops are located 120 feet in front of the switch points, and at the clearance point of the turnout. Prior to occupying the presence detection loops, select radio channel 15, press #1 1 6 5 to line the switch in the opposite position. Pressing #1 1 6 5 again will line the switch to the original position. If a presence detection loop is occupied the switch will not throw.

**2) PUSH BUTTON OPERATION:**

The push button operation is similar to the remote control in that the presence detection loops will prevent the switch from throwing when a car or locomotive is on the loop. To operate the switch using the push button, remove the lock on the box marked PB and press the black button inside. This will line the switch to the opposite position.

**3) MANUAL OPERATION:**

To operate the switch manually follow the attached instructions. It will take about 20 pumps on the handle to complete the movement of the switch points from one position to the other.

**Remember:** This is a remote controlled switch that can be operated at any time unless you provide protection against unwanted movement. Always check the position of the switch points and the lights on the illuminated switch target to determine that the switch is properly lined for your movement.

**MAINTENANCE:**

When necessary to perform maintenance on or around the switch points the maintenance box must be unlocked and the switch moved to the OFF position. This will prevent the switch from being thrown either remotely or by using the push button. With the maintenance

**switch in the off position, it is necessary to manually pump the switch to the desired position.**

Crossing signal located at First and Post Streets will activate only by using the manual start button located within the key box (accessible with a switch key) placed adjacent to the track for either approach, or on the signal control cabinet.

Anchorage diesel shop area tracks between South Roundhouse Lead Switch and Backshop Lead Switch are designated locomotive servicing area tracks, and maximum authorized speed in these limits is **walking speed**.

The maximum speed on Anchorage Car Shop Tracks 1, 2, 3, and 4 is walking speed.

Excepted Track Within Anchorage Yard

The track listed below is designated as excepted track as provided in Operating Rule 6.12.

DESCRIPTION

OVL2, 2 ½  
General Electric - Inside  
Wrightway Old 1  
Ash Track  
CEA Inside  
CEA Outside  
Warehouse 1 & 3  
Back Shop Lead  
Mechanical Office Track  
Wheel Shop 2  
On-Track Equipment Storage  
General Repair  
Back Shop Lead  
Electric Shop and Diesel Shop  
Heavy Equipment

**82.5 MP 117 CROSSOVER TO SW MP 119.8**

**CTC limits are in effect on East Main Track and West Main Track between CP 1170 (MP 117 Crossover) and CP 1198 (Switch MP 119.8).**

## **82.6 FORT RICHARDSON**

**Use row B on Determining Number of Hand Brakes to Apply Table to determine number of hand brakes to be secured at this location.**

Close clearance on all tracks at Fort Richardson.

During switching operations on Fort Richardson, air brakes must be cut in and operative.

SD70MAC locomotives are prohibited on all tracks.

## **82.7 MP 123**

Southward trains will contact the Terminal Superintendent's office for yarding instructions in Anchorage Yard. If unable to contact the Terminal Superintendent, contact the Train Dispatcher.

## **82.8 REVES**

**Use row B on Determining Number of Hand Brakes to Apply Table to determine number of hand brakes to be secured at this location.**

**CTC limits are in effect on main track and siding between south siding switch and north siding switch.**

## **82.9 POWDER SPUR MP 131**

**Use row B on Determining Number of Hand Brakes to Apply Table to determine number of hand brakes to be secured at this location.**

Powder Spur MP 131 is out of service unless authorized to occupy track by an engineering supervisor.

## **82.10 BIRCHWOOD**

**Use row B on Determining Number of Hand Brakes to Apply Table to determine number of hand brakes to be secured at this location.**

Track 1 is the designated siding.



Tracks 2 and 3 will be used for set-outs and storage, unless otherwise instructed.

Track 2 out of service from a point 700 feet south of north switch to a point 3000 feet north of south switch unless authorized to occupy track by engineering supervisor.

SD70MAC locomotives prohibited on tracks 2 and 3.

Do not exceed 5 m.p.h. on Tracks 2 and 3.

L.P.G. transfer facility located off north end of Track 2.

Close clearance at side dock at Spenard Builder's Supply.

## **82.11 EKLUTNA**

**Use row B on Determining Number of Hand Brakes to Apply Table to determine number of hand brakes to be secured at this location.**

Do not exceed walking speed and closely observe leading wheels on Ramp Track off Pit Track MP 142.

SD70MAC locomotives prohibited on pit and ramp track.

## **82.12 MATANUSKA**

**Use row B on Determining Number of Hand Brakes to Apply Table to determine number of hand brakes to be secured at this location.**

SD70MAC locomotives prohibited beyond clearance point.

**The south siding switch at Matanuska has been removed.**

**Matanuska siding is a stub track heading in from the north, measuring 1,320 feet in length.**

## **82.13 PALMER JUNCTION**

**Use row B on Determining Number of Hand Brakes to Apply Table to determine number of hand brakes to be secured at this location.**

**CTC limits are in effect at south siding switch, CP 1505.**

Palmer Branch begins and ends at tail of the wye switch Palmer Jct.

The wye is the designated siding.

When opposing trains meet at Palmer Junction and the northbound train is required to pull by and back into the north leg of wye, the southbound train must stop short of MP 152.1 and not proceed until the northbound train's movement south is clear of MP 151.3 to allow proper operation of highway crossing signals MP 151.6.

**82.14 SPENARD BUILDERS SUPPLY  
MP 158.7**

**Use row B on Determining Number of Hand Brakes to Apply Table to determine number of hand brakes to be secured at this location.**

SD70MAC locomotives prohibited from clearance point to end of track.

**82.15 WASILLA**

**Use row B on Determining Number of Hand Brakes to Apply Table to determine number of hand brakes to be secured at this location.**

**Do not exceed 5 MPH in Wasilla siding over Knik-Goose Bay Road crossing, MP 159.9, until the leading wheels occupy the crossing.**

SD70MAC locomotives prohibited between clearance points at south and north ends of siding.

**82.16 SPENARD BUILDERS SUPPLY  
MP 161.6**

**Use row B on Determining Number of Hand Brakes to Apply Table to determine number of hand brakes to be secured at this location.**

SD70MAC locomotives prohibited between clearance points at south and north ends of track.

**82.17 PITTMAN**

**Use row B on Determining Number of Hand Brakes to Apply Table to determine number of hand brakes to be secured at this location.**

**CTC limits are in effect on main track and siding between south siding switch and north siding switch.**

## **82.18 HOUSTON**

**Use row B on Determining Number of Hand Brakes to Apply Table to determine number of hand brakes to be secured at this location.**

SD70MAC locomotives prohibited between clearance points.

## **82.19 WILLOW**

**Use row B on Determining Number of Hand Brakes to Apply Table to determine number of hand brakes to be secured at this location.**

Willow Wye out of service unless authorized for use by an engineering supervisor.

SD70MAC locomotives prohibited on wye.

## **82.20 KASHWITNA**

**Use row B on Determining Number of Hand Brakes to Apply Table to determine number of hand brakes to be secured at this location.**

SD70MAC locomotives prohibited between clearance points.

## **82.21 CASWELL**

**Use row B on Determining Number of Hand Brakes to Apply Table to determine number of hand brakes to be secured at this location.**

SD70MAC locomotives prohibited between clearance points.

## **82.22 MONTANA**

**Use row B on Determining Number of Hand Brakes to Apply Table to determine number of hand brakes to be secured at this location.**

## **82.23 MONTANA CREEK BRIDGE, MP 211**

Warning bells are installed on bridge as a warning of an approaching train. The bells are activated whenever a train is approaching the bridge. A yellow strobe light is located on the south end of the bridge to indicate the bells are operating. This system is in use during the period June 1 through September 30. Malfunction of this system must be reported to the train dispatcher.

## **82.24 SUNSHINE**

**Use row B on Determining Number of Hand Brakes to Apply Table to determine number of hand brakes to be secured at this location.**

## **82.25 LOG TRACK MP 223.6**

**Use row C on Determining Number of Hand Brakes to Apply Table to determine number of hand brakes to be secured at this location.**

**Pit Track off Log Track MP 223.6 out of service unless authorized to occupy track by engineering supervisor.**

Do not exceed walking speed on Log Track MP 223.6 and on Pit Track off Log Track 223.6. SD70MAC locomotives prohibited between clearance points at south and north ends.

## **82.26 TALKEETNA**

**Use row B on Determining Number of Hand Brakes to Apply Table to determine number of hand brakes to be secured at this location.**

**East side stub track, switch MP 227.1, is the designated siding.**

SD70MAC locomotives prohibited on House track between south switch and clearance point of north switch and on Ramp track.

Do not tie up equipment with engine running on north end of house track.

Do not exceed walking speed on Talkeetna House Track.

## **82.27 CHASE**

**Use row B on Determining Number of Hand Brakes to Apply Table to determine number of hand brakes to be secured at this location.**

## **82.28 CURRY**

**Use row B on Determining Number of Hand Brakes to Apply Table to determine number of hand brakes to be secured at this location.**

SD70MAC locomotives prohibited on wye tracks.

## **82.29 SUSITNA**

**Use row B on Determining Number of Hand Brakes to Apply Table to determine number of hand brakes to be secured at this location.**

## **82.30 SHERMAN**

**Use row B on Determining Number of Hand Brakes to Apply Table to determine number of hand brakes to be secured at this location.**

SD70MAC locomotives prohibited between clearance points.

## **82.31 GOLD CREEK**

**Use row B on Determining Number of Hand Brakes to Apply Table to determine number of hand brakes to be secured at this location.**

Close clearance at side ramp on outfit track.

Do not exceed 5 MPH on Carr Outfit Track off Gold Creek Siding.

SD70MAC locomotives prohibited on Carr Outfit Track, off siding.

## **82.32 CANYON**

**Use row B on Determining Number of Hand Brakes to Apply Table to determine number of hand brakes to be secured at this location.**

Canyon Spur out of service unless authorized for use by an engineering supervisor.

SD70MAC locomotives prohibited beyond clearance point.

### **82.33 CHULITNA**

**Use row B on Determining Number of Hand Brakes to Apply Table to determine number of hand brakes to be secured at this location.**

Chulitna Wye out of service unless authorized to occupy tracks by an engineering supervisor.

SD70MAC locomotives prohibited between clearance points of siding and on wye tracks.

### **82.34 HURRICANE**

**Use row B on Determining Number of Hand Brakes to Apply Table to determine number of hand brakes to be secured at this location.**

**CTC limits are in effect on main track and siding between south siding switch and north siding switch.**

**Close clearance at Engineering Track side ramp. SD70MACs prohibited on the Engineering Track.**

### **82.35 HONOLULU**

**Use row B on Determining Number of Hand Brakes to Apply Table to determine number of hand brakes to be secured at this location.**

### **82.36 COLORADO**

**Use row B on Determining Number of Hand Brakes to Apply Table to determine number of hand brakes to be secured at this location.**

### **82.37 BROAD PASS**

**Use row B on Determining Number of Hand Brakes to Apply Table to determine number of hand brakes to be secured at this location.**

SD70MAC locomotives prohibited on wye tracks.

### **82.38 SUMMIT**

**Use row B on Determining Number of Hand Brakes to Apply Table to determine number of hand brakes to be secured at this location.**

### **82.39 CANTWELL**

**Use row B on Determining Number of Hand Brakes to Apply Table to determine number of hand brakes to be secured at this location.**

SD70MAC locomotives prohibited between clearance point at south end and ramp track switch and on ramp track.

### **82.40 WINDY**

**Use row B on Determining Number of Hand Brakes to Apply Table to determine number of hand brakes to be secured at this location.**

SD70MAC locomotives prohibited on outfit track.

### **82.41 MP 333.7 HOUSE TRACK**

**Use row B on Determining Number of Hand Brakes to Apply Table to determine number of hand brakes to be secured at this location.**

Close clearance at side ramp on house track.

SD70MAC locomotives are prohibited beyond clearance point.

**82.42 CARLO**

Use row B on Determining Number of Hand Brakes to Apply Table to determine number of hand brakes to be secured at this location.

**82.43 OLIVER**

Use row C on Determining Number of Hand Brakes to Apply Table to determine number of hand brakes to be secured at this location.

**82.44 DENALI PARK**

Use row C on Determining Number of Hand Brakes to Apply Table to determine number of hand brakes to be secured at this location.

SD70MAC locomotives prohibited from a point 900 feet south of north switch to clearance point of south switch.

**82.45 CASCADE OUTFIT TRACK**

Use row C on Determining Number of Hand Brakes to Apply Table to determine number of hand brakes to be secured at this location.

SD70MAC locomotives prohibited on outfit track.

**82.46 GARNER**

Use row B on Determining Number of Hand Brakes to Apply Table to determine number of hand brakes to be secured at this location.

Garner siding out of service from a point 400 feet south of north switch to south switch unless authorized to occupy track by an engineering supervisor.

SD70MAC locomotives prohibited on siding unless authorized by an engineering supervisor.



## **82.47 HEALY CANYON BETWEEN DENALI PARK AND HEALY**

Crew member on all trains except trains operating without a caboose will position themselves in such a manner as to make careful inspection of track to rear of train for indications of derailments so that train may be stopped immediately.

Dynamic brakes must be restricted to one-half of maximum on trains operating northbound between Denali Park and Healy.

Area subject to falling rock between MP 349 and MP 358.

**Moody Tunnel is located at MP 353.6.**

## **82.48 GARNER TUNNEL**

**Garner Tunnel is located at MP 356.2.**

Do not exceed restricted speed while approaching north portal of Garner Tunnel until track is seen to be clear of rocks and/or debris.

## **82.49 HEALY**

**Use row B on Determining Number of Hand Brakes to Apply Table to determine number of hand brakes to be secured at this location.**

West 1 Track is the designated siding.

Tail of Wye Track is 725 feet long.

Close clearance at side ramp on ramp track, between tracks East 2 and East 3 and at south end of Outfit Track.

Yard lights switch is located on the outside wall of the air compressor shed. These lights, once activated, are on a timer and will automatically turn off after a preset period of time.

SD70MAC locomotives prohibited from the following tracks: East Track 2 (off East Track 1), East Track 3 (off East Track 2), Old Rip Track, Roundhouse Tracks 1 & 2, Crane Track, New Rip Track, Outfit Track, Ramp Track and New Storage Track.

**Whenever cars are set out on East 1 or East 2, in addition to setting the switch point derail at the north end of East 1 in the derailing position, the derail at the north end of the New Storage track must also be set in the derailing position.**

## **82.50 USIBELLI TIPPLE**

**Use row B on Determining Number of Hand Brakes to Apply Table to determine number of hand brakes to be secured at this location.**

Do not exceed 5 MPH through the tipple tunnel.

A green light is located across from the tipple operator's control station that, when illuminated, indicates the loading chute is in its fully raised position. In absence of this signal, the crew must ascertain the loading chute is in its fully raised position before proceeding.

If necessary to run locomotives around train prior to loading, empty hoppers will be left just outside tipple door to enable mine personnel to begin their inspection of the cars while locomotives are en route to opposite end of train.

Locomotives will not be left standing in the tunnel or within 50 feet (outside) of either portal. The amount of time a locomotive is in the tunnel is to be kept at a minimum.

Any coal train exceeding 71 cars must pull locomotives north of the north portal.

Conductors of trains operating in this area will be required to coordinate all movements with the tipple operator. A crew member must contact the tipple operator prior to releasing any hand brakes, coupling locomotives to empty train, or releasing train air brakes on train being prepared for loading.

The motion scale is located 60 feet from the north tunnel portal.

Signs reading "No motor vehicles past this point" indicate the limits of the scale and are located on the east wall of the tunnel. These signs may be used for reference points when it is necessary to clear the scale.

All trains loading in this facility proceed as directed by mine personnel.

Notify Train Dispatcher when circumstances arise that may increase expected loading time.

Loading speed is approximately .34 m.p.h. The speed is to be increased or decreased as loading operations dictate. In the event the movement exceeds 1 m.p.h. it may be necessary to stop the movement and back train south of the scale and begin scaling again. Engineers working trains through the tunnel must control speed of train to prevent making an air application during scaling.

When entire train has been loaded and last car clears the track scale, a reverse movement may be made over the track scale.

Cars will not be set out or left standing on the Usibelli Tipple track without authorization from the Train Dispatcher. Should conditions require a car to be set out or left standing on the track, brakes must be properly secured and the car chained or chocked.

Length of main track from clearance point NSS to middle of Usibelli Tipple road crossing is 4237 feet.

Length of main track from clearance point SSS to middle of Usibelli Tipple road crossing is 3406 feet.

The south switch of the Industry track serving Usibelli coal loading tipple is located at MP 361.51; the north switch is located at MP 362.92. Use of this track restricted to industrial use only.

SD70MAC locomotives prohibited on Outfit track, Lignite.

Employees working in this structure must wear hard hats.

Length of track from clearance point SSS to south portal of tipple is 4247 feet. The small road crossing may be blocked when necessary to provide clearance on the south end of track.

Length of track from clearance point NSS to north portal of tipple 4010 feet.

Close clearance at north end of tunnel.

The tipple tunnel is 265 feet long.

### **EXPORT COAL**

Empty trains left to be loaded with the locomotives parked outside the north loading tunnel portal, due to train length, must not back up until the tipple operator is ready to load the train. After the tipple operator acknowledges he is ready to load the train, back the train to clear the scale and remain until advised to proceed at loading speed.

Notify dispatcher when train is half loaded.

When 60 to 65 cars are loaded, ascertain from tipple operator if there is sufficient coal to finish the load. If necessary, pause to recharge tipple with coal prior to gaining authority to mainline to finish loading.

To run locomotives around train after loading: after clearing scale, back train approximately eight cars, leaving two cars out of the south tunnel.

## **LOCAL COAL**

Conductors of local coal trains must furnish the tipple operator an accurate consist of all cars picked up on line to be loaded. This consist will be in addition to the pickup and set out report that is turned in at Fairbanks.

**North end local coal trains on arrival at Usibelli Tipple, unless otherwise instructed, will pull by south switch, back into the siding and spot train at the road crossing just south of the tipple door for door inspection and tie train down. If a yard crew is on duty, they should be at the south switch to line the movement into the siding.**

### **82.51 FERRY**

**Use row B on Determining Number of Hand Brakes to Apply Table to determine number of hand brakes to be secured at this location.**

SD70MAC locomotives prohibited between clearance points.

### **82.52 BEAR CREEK**

**Use row B on Determining Number of Hand Brakes to Apply Table to determine number of hand brakes to be secured at this location.**

### **82.53 BROWNE**

**Use row B on Determining Number of Hand Brakes to Apply Table to determine number of hand brakes to be secured at this location.**

SD70MAC locomotives prohibited between clearance points.

### **82.54 MP 388 PIT TRACK**

**Use row B on Determining Number of Hand Brakes to Apply Table to determine number of hand brakes to be secured at this location.**

SD70MAC locomotives prohibited from 300 feet past clearance point on south leg of wye. SD70MAC locomotives prohibited from tail of wye.

## **82.55 CLEAR SITE**

**Use row B on Determining Number of Hand Brakes to Apply Table to determine number of hand brakes to be secured at this location.**

Trains performing switching in such a manner that would block highway crossings and/or activate crossing signals must leave train back a sufficient distance from crossing while performing such switching so as to not activate crossing signals or block crossing.

## **82.56 MILE POSTS 394 A AND 394 B**

Track realignments resulted in adding MP 394 A and MP 394 B.

## **82.57 MAINTENANCE TRACK MP 401.1**

**Use row B on Determining Number of Hand Brakes to Apply Table to determine number of hand brakes to be secured at this location.**

Maintenance Track Mile 401.1 out of service unless authorized by an engineering supervisor.

## **82.58 NENANA**

**Use row B on Determining Number of Hand Brakes to Apply Table to determine number of hand brakes to be secured at this location.**

Long Siding Track is the designated siding.

SD70MAC locomotives prohibited on Long Pass track between clearance points at south and north ends of siding; on Waterfront track between a point 500 feet north of south switch to clearance point at north end of track and on House track at clearance point to end of track. SD70MACs also prohibited from South end little yard.

Engineering Track is 440 feet long. Trains operating on this track must not use more than one locomotive.

Close clearance on Union Oil Spur 300 feet south of switch. The switch to this track is to be left lined for the Main Track.

Engineering Spur (formally south leg of wye), Hi-Line Track, **Track 1 from the north switch to end of track sign, Track 2 from the north switch to the red flag, and Track 3 out of service unless authorized to occupy track by an engineering supervisor.**

**Do not exceed walking speed on Waterfront Track. Do not shove cars or cross the Market Street crossing (the first grade crossing south of the Ice Classic timing tower) on the Waterfront track.**

## **82.59 NORTH NENANA**

**Use row B on Determining Number of Hand Brakes to Apply Table to determine number of hand brakes to be secured at this location.**

Engineering spur out of service unless authorized by an engineering supervisor.

## **82.60 MANLEY**

**Use row B on Determining Number of Hand Brakes to Apply Table to determine number of hand brakes to be secured at this location.**

## **82.61 DUNBAR**

**Use row B on Determining Number of Hand Brakes to Apply Table to determine number of hand brakes to be secured at this location.**

## **82.62 OUTFIT TRACK MP 432.6**

**Use row B on Determining Number of Hand Brakes to Apply Table to determine number of hand brakes to be secured at this location.**

Outfit track MP 432.6 out of service unless authorized by an engineering supervisor.

## **82.63 STANDARD**

**Use row B on Determining Number of Hand Brakes to Apply Table to determine number of hand brakes to be secured at this location.**

SD70MAC locomotives prohibited beyond clearance point.

## **82.64 SAULICH**

**Use row B on Determining Number of Hand Brakes to Apply Table to determine number of hand brakes to be secured at this location.**

Northward trains contact the Fairbanks Operation Support Technician via radio telephone, extension 6022, for yarding instructions in Fairbanks Yard. If unable to contact Operation Support Technician, contact the Train Dispatcher.

## **82.65 DOME**

**Use row A on Determining Number of Hand Brakes to Apply Table to determine number of hand brakes to be secured at this location.**

Dome Spur Track out of service unless authorized to occupy track by an engineering supervisor.

SD70MAC locomotives prohibited beyond clearance point.

## **82.66 HAPPY**

**Use row B on Determining Number of Hand Brakes to Apply Table to determine number of hand brakes to be secured at this location.**

SD70MAC locomotives prohibited beyond clearance point.

## **82.67 FAIRBANKS**

**Use row B on Determining Number of Hand Brakes to Apply Table to determine number of hand brakes to be secured at this location.**

## Anchorage Subdivision Special Instructions

---

All trains departing the Fairbanks terminal must be given a roll-by inspection by a qualified employee.

**If unable to contact the assistant terminal superintendent or operations support technician, each train, engine, track car or employee working on or near a track, will announce its intention to move within, or enter into, the yard limit territories.**

Fairbanks Diesel Shop Tracks 3, 4 and 5 are designated as locomotive servicing area tracks. The maximum authorized speed on these tracks is **walking speed**.

The maximum authorized speed on Fairbanks Car Shop Tracks 1 and 2 is **walking speed**.

F.E. Lead out of service north of O.K. Lumber Company. O.K. Lumber switch is spiked for movement into O.K. Lumber.

Do not exceed 5 MPH on UAF track MP 467. A locomotive will not clear coal shed doors.

### Excepted Tracks, Fairbanks Yard

The tracks listed below are designated excepted track as provided in Operating Rule 6.12.

#### DESCRIPTION

Fidelity  
O.K.Lumber



**82.68 PALMER BRANCH**

SOUTH ↓		<b>Auxiliary Track</b>			↑ NORTH	
Call Code	Capacity of siding	<b>STATIONS</b>		Mile Post	Meth. of Opr.	Detector Locations
		Palmer		A 6.2	<b>Rule 6.28</b>	
<b>02</b>		62	Palmer Junction JY	A 0.0		

**82.68.1 METHOD OF OPERATION**

Location	Method
A 0.0 - A 6.20	GCOR Rule 6.28

**82.68.2 MAXIMUM AUTHORIZED SPEEDS**

Maximum Authorized Speed Between:	In MPH For:
	Frt Psgr
MP A 0.00 and MP A 6.20 .....	10 10

**82.68.3 LOCATION OF OTHER TRACKS**

MP		Switch Location	Capacity in Feet
A 1.44	<b>QAP</b> Switch to Gravel Loop .....	S	9,387
A 2.43	Wilder Switch to Gravel Loop .....	S	9,387
A 4.92	Armco .....	S	586
A 4.99	Industrial Park Lead (Airport Spur) .....	S	6,109
A 4.99	Big 3, off Industrial Park Lead .....	S	1,053
A 4.99	Track 2, off Industrial Park Lead .....	S	506
A 6.2	House Track .....	Both	1,150
A 6.2	Ramp Track, off House Track .....	N	195
A 6.24	Mat Maid .....	N	977
A 6.5	Palmer Siding .....	Both	1,240

## **82.68.4 PALMER BRANCH SPECIAL INSTRUCTIONS**

Structures at tipple on Gravel Loop MP A 2.43 will not clear a person on side of car.

Conductors of commercial gravel trains will call the Train Dispatcher when their train is half-loaded and give dispatcher estimated time of departure (ETD) from Palmer Junction.

Mat Maid Track MP A 6.24 is out of service, unless authorized by an engineering supervisor.

Palmer siding Mile A 6.5 is out of service unless authorized by an engineering supervisor.

**Big 3 track is out of service unless authorized by an engineering supervisor.**

SD70MAC locomotives prohibited beyond MP A 4.0.

**82.69 SUNTRANA BRANCH**

SOUTH ↓		<b>Auxiliary Track</b>			↑ NORTH	
Call Code	Capacity of siding	<b>STATIONS</b>		Mile Post	Meth. of Opr.	Detector Locations
		End of Track		<b>D 1.7</b>	Rule 6.28	
00		1.7	Healy JBYW	D 0.0		

**82.69.1 METHOD OF OPERATION**

Location	Method
D 0.0 - D 1.70	GCOR Rule 6.28

**82.69.2 MAXIMUM AUTHORIZED SPEEDS**

Maximum Authorized Speed Between:	In MPH For:	Frt	Psg
MP D 0.00 and MP <b>D 1.7</b> .....	10	10	

**82.69.3 SUNTRANA BRANCH SPECIAL INSTRUCTIONS**

When spotting more than one railcar at Usibelli Prill Silo, MP D 1.5, spot **north** car under silo with any additional loads toward end of track.

SD70MAC locomotives prohibited beyond MP D 0.5.

**Do not leave any railcars attached to cars on spot at Prill Silo.**

**82.70 FAIRBANKS INTERNATIONAL AIRPORT BRANCH**

SOUTH ↓		<b>Auxiliary Track</b>		↑ NORTH	
Call Code	Capacity of siding	STATIONS	Mile Post	Meth. of Opr.	Detector Locations
		End of Track	H 10.0		
		10.0		Rule 6.28	
03		Fairbanks JBWLZ	H 0.0		

**82.70.1 METHOD OF OPERATION**

Location	Method
H 0.0 - H 10.00	GCOR Rule 6.28

**82.70.2 MAXIMUM AUTHORIZED SPEEDS**

Maximum Authorized Speed Between:	In MPH For:
	Frts Psgr
MP H 0.00 and MP H 10.00 .....	10 10

**82.70.3 LOCATION OF OTHER TRACKS**

MP	Name	Switch Location	Capacity in Feet
H 0.0	Airport Branch Switch		
H 1.0	FS&G Spur .....	N	
H 2.8	North Star Terminal .....	N	
H 2.9	Northland Wood .....	S	
H 3.6	Alaska West Track 1 .....	N	
H 3.6	Alaska West Track 2 .....	N	
H 3.7	Great Western Track 1 .....	S	600
H 4.1	Parker Runaround .....	Both	1,900
H 4.9	Metro Siding .....	Both	1,143
H 9.3	Tesoro .....	S	
H 9.5	Chevron .....	S	
H 9.6	Runaround .....	Both	880

## **82.70.4 FAIRBANKS INTERNATIONAL AIRPORT BRANCH SPECIAL INSTRUCTIONS**

Fairbanks International Airport Branch out of service at MP H 5.5 unless authorized by an engineering supervisor.

Riding on the building side of cars at Northstar Terminal is prohibited.

Close clearance at door 805 where steps have been built. Do not exceed walking speed while moving past these steps.

Do not exceed 5 m.p.h. on North Star Terminal Lead between Cushman Street Crossing and the gate.

SD70MAC locomotives prohibited from H 0.5 to end of track.

*Confidence,  
determination, and  
positive thinking  
can put you on the  
right track.*

**82.71 EIELSON BRANCH**

SOUTH ↓		<b>Auxiliary Track</b>		↑ NORTH	
Call Code	Capacity of siding	<b>STATIONS</b>	Mile Post	Meth. of Opr.	Detector Locations
		Eielson <small>11.6</small>	G 28.0		
	<b>4,065</b>	Chapados <small>0.5</small>	G 16.4		
	<b>1,496</b>	North Pole <small>12.1</small>	G 15.9	Rule 6.28	
		Fort Wainwright <small>0.5</small>	G 3.8		
03		Fairbanks <small>BJLWZ</small>	G 0.0		

**82.71.1 METHOD OF OPERATION**

Location	Method
G 0.00 - G 28.00	GCOR Rule 6.28

**82.71.2 MAXIMUM AUTHORIZED SPEEDS**

Maximum Authorized Speed Between:	In MPH For:	Frt	Psgr
MP G 0.00 and MP G 3.20 .....	15	15	
MP G 3.20 and MP G 6.20 .....	10	10	
MP G 6.20 and MP G 24.50 .....	20	20	
MP G 24.50 and End of Track .....	10	10	

**82.71.3 LOCATION OF OTHER TRACKS**

MP		Switch Location	Capacity in Feet
G 1.2	TAPS .....	S	2,607
G 3.5	Ladd Main .....	S	2,070
G 4.9	Warehouse 1 .....	S	1,144

## Anchorage Subdivision Special Instructions

G	5.0	Fort Wainwright Power Plant .....	S	1,197
G	5.4	Bob Small Runaround .....	Both	1,131
G	6.0	Fairbanks International Airport .....	S	
G	8.1	Salvage Yard .....	S	332
G	9.9	K & K .....	S	1,390
G	12.4	Green Construction .....	N	299
G	16.6	Mapco Refinery Main .....	S	4,282
G	24.1	Bluff Spur .....	N	422

### 82.71.4 EIELSON BRANCH SPECIAL INSTRUCTIONS

The switch targets at Chapados Siding, when lined for the siding, will display yellow indication, and when lined for the main, will display green indication. These switches may be left lined and locked in either position.

Do not exceed 5 m.p.h. on Ladd Main.

Do not exceed 5 m.p.h. on Outside Power Plant Track at Fort Wainwright.

Do not exceed walking speed on Building 3030 Track mile G 4.94.

Conductors that switch NPR will show on their timeslip:

- departure time from Fairbanks
- time first load is pulled
- time last empty is spotted
- arrival time at Fairbanks.

In operations of yard movements between Fairbanks and Eielson, Fort Wainwright or Airport Spur, air brakes must be cut in and operative.

Yard crew picking up or setting out at North Pole will leave cars to provide clear passage of vehicle traffic over either 5<sup>th</sup> or 8<sup>th</sup> Avenue.

ARRC maintained track ends at MP G 24.5.

SD70MAC locomotives prohibited beyond G 17.8.

#### **NORTHPOLE REFINERY POWERSWITCH OPERATION:**

The illuminated switch target provides the following information:

Green: Switch points fit properly in normal position.

Red: Switch points fit properly in reverse position.

In addition, the lights flash alternately red and green when the switch is in transition between normal and reverse positions, or if the switch fails to complete the throw to the full normal or reverse position. If the lights are flashing, the switch must be operated by hand to the desired position, and the switch points checked to ensure they are in the proper position. Any malfunction of this switch or electronic switch target must be reported to the Operations Support Technician.

The switch can be operated in one of three ways:

### **1) REMOTE CONTROL OPERATION:**

The presence detection loops must not be occupied by a car or locomotive. These loops are located 120 feet in front of the switch points, and at the clearance point of the turnout. Prior to occupying the presence detection loops, select radio channel 6, press #4166 to line the switch in the reverse position. Pressing #4166 again will not return the switch to the normal position, unless the RESTORE switch is in the off position. If a detection loop is occupied the switch will not throw. In addition to the protection provided by the loops the end loops provide a restore feature that will restore the switch to the normal position 10 minutes after the loop is cleared. If the presence detection loops are not occupied the switch will return to the normal position in 10 minutes.

### **2) PUSHBUTTON OPERATION:**

The push button operation is similar to the remote control in that the presence detection loops will prevent the switch from throwing when a car or locomotive is on the loop. To operate the switch using the push button, remove the lock on the box marked PB and press the black button inside. This will line the switch to the reverse position. The switch will restore to the normal position in 10 minutes.

### **3) MANUAL OPERATION:**

To operate the switch manually follow the attached instructions. It will take about 20 pumps on the handle to complete the movement of the switch points from one position to the other.



**AUTO-RESTORE:**

This feature is used to restore the switch to the normal position after the presence detection loops are clear and the 10 minute timer has run, or if nothing is on the presence detections loops the switch will restore to the normal position after the 10 minute timer has run. The auto-restore can be disabled by unlocking the box on the switch stand that is labeled RESTORE, and moving the toggle switch to the OFF position. With the switch in the OFF position the switch can be thrown normal and reverse without waiting for the timer to run as long as the presence detection loops are not occupied. This switch must be left in the ON position when not used for immediate switching moves. If the switch is left in the OFF position the auto-restore will not line the switch back to the normal position.

**MAINTENANCE:**

When necessary to perform maintenance on or around the switch points the maintenance box must be unlocked and the switch moved to the OFF position. This will prevent the switch from being thrown either remotely or by using the push button. With the maintenance switch in the off position, it is necessary to manually pump the switch to the desired position.

**82.72 ANCHORAGE SUBDIVISION GRADE  
PROFILES**

*Teamwork and  
communications  
prevent accidents  
and complications.*

# Anchorage Subdivision Special Instructions

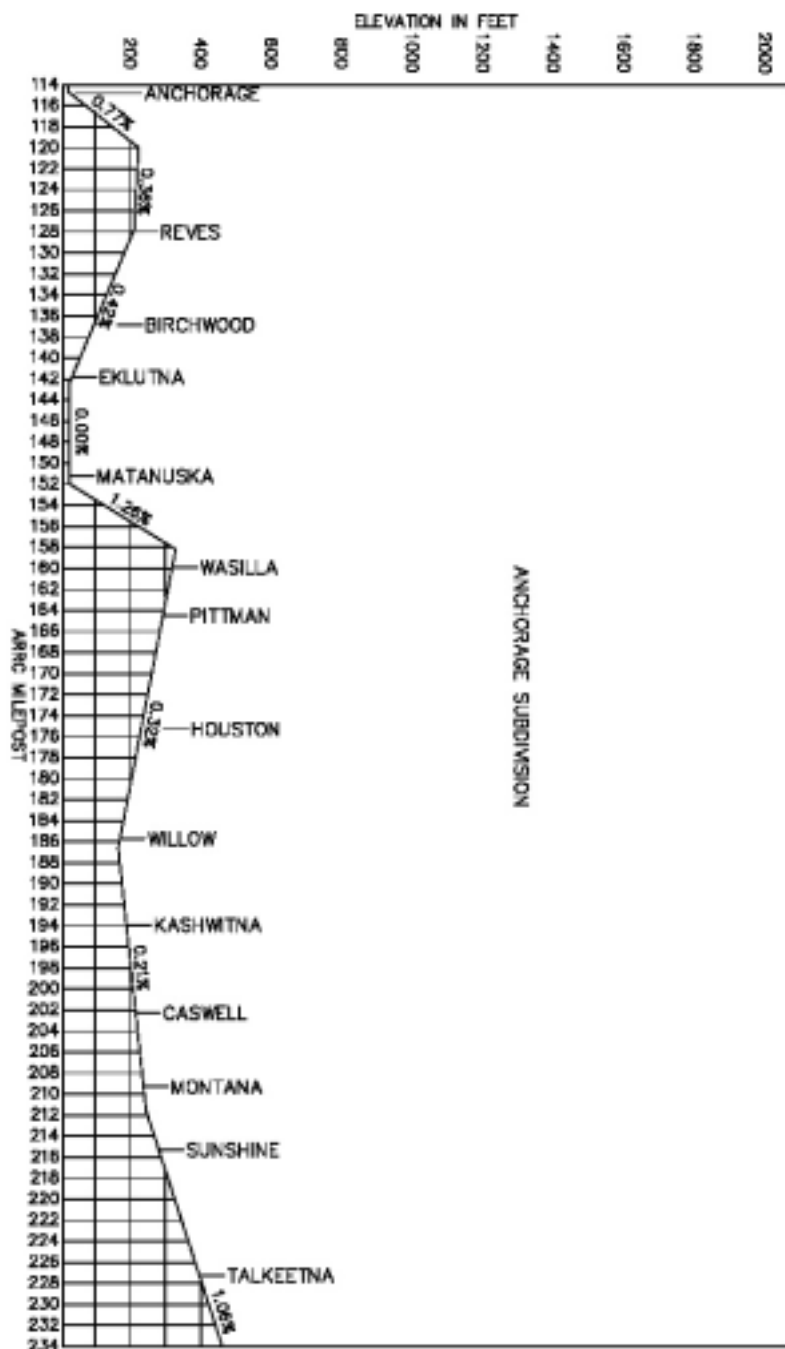

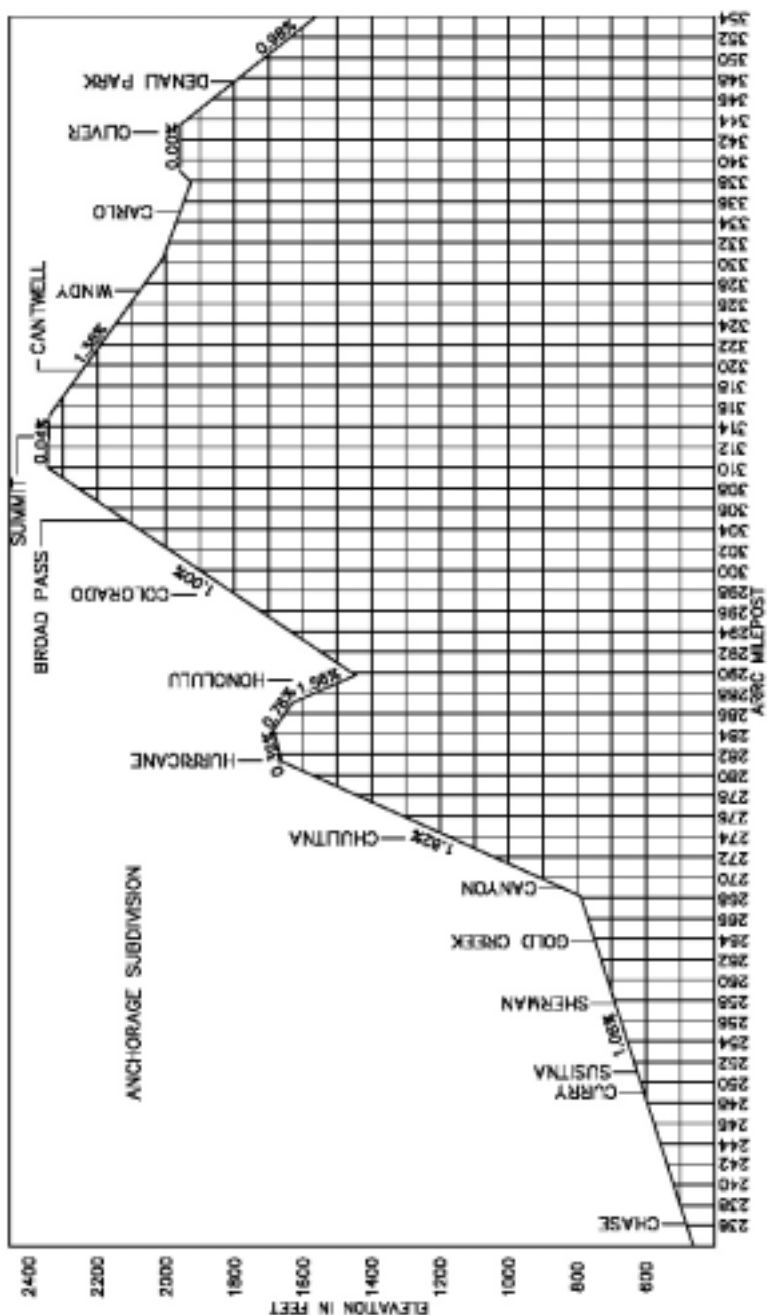

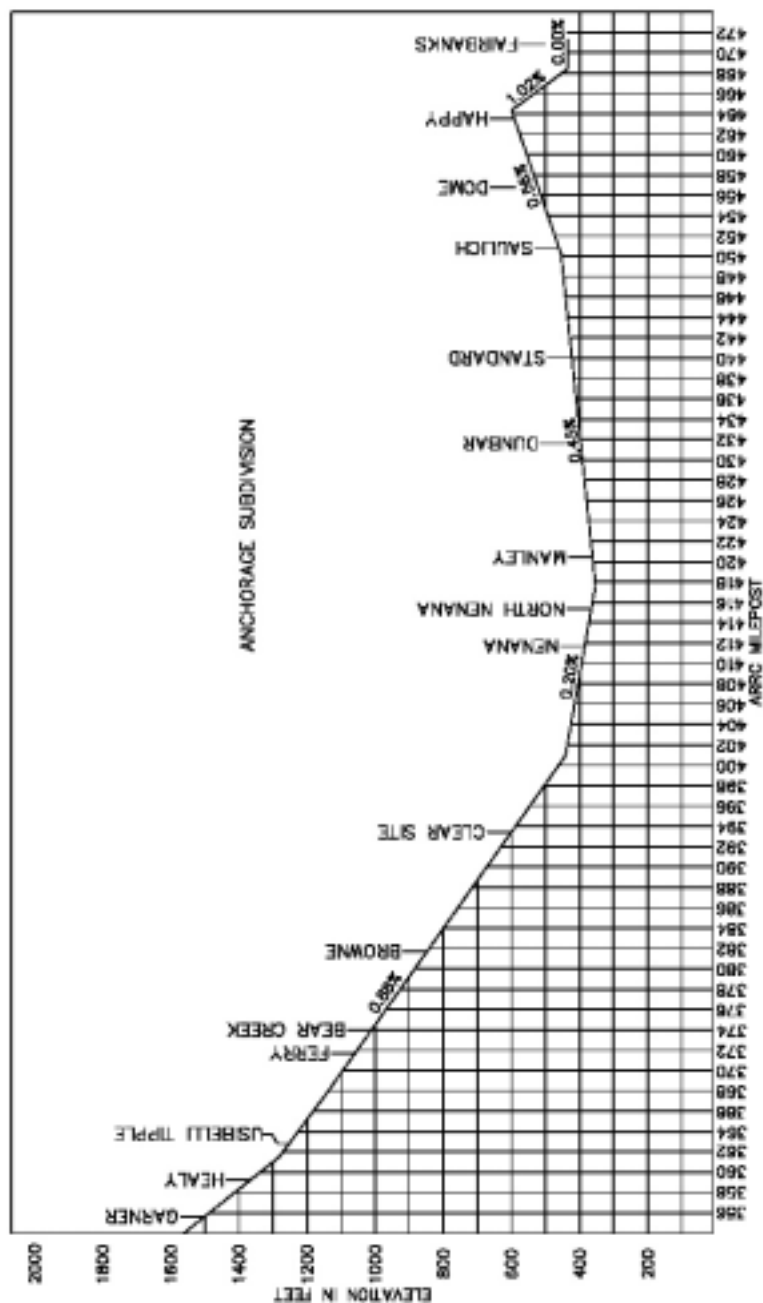

## **83.0 SPECIAL INSTRUCTIONS, ALL SUBDIVISIONS**

Changes in the Special Instructions from the previous Timetable will be shown in bold type for the life of the new Timetable only. This practice will not relieve employees whose duties are affected in any way by the Timetable from reading and complying with all instructions contained herein.

### **83.1 GENERAL ORDERS**

General Orders containing information affecting the safety or movement of trains and engines will be issued and cancelled by the Chief Operating Officer, and will be posted at locations designated in the Timetable.

General Orders containing instructions that modify or make reference to a physical plant change will be removed after having been in effect for a period of 60 days. Such instructions or modifications will remain in effect.

### **83.2 OPERATING CIRCULARS**

Employees in train, engine, hostling, or yard service must be familiar with information contained in Operating Circulars, and will be held accountable for the information contained therein.

### **83.3 TRACK AND TIME**

**Track cars granted track and time to enter CTC limits must operate as prescribed by ARSM Chapter 42: Operating Track Cars. The latest General Order number and Form B information must be confirmed before commencing each tour of duty.**

### **83.4 MINIMUM FLAGGING DISTANCE**

Minimum flagging distance on all subdivisions as prescribed by GCOR Rule 6.19 is one mile.

### **83.5 TRAIN OPERATIONS AT SIDINGS**

Except as shown below, revenue freight trains are prohibited from backing into or out of sidings.

Exceptions, revenue freight trains may:

- back into or out of Palmer Junction.
- back into or out of Healy Track West 2.
- back into or out of Usibelli Tipple.
- back into sidings as required when necessary for doubling or performing work.

### **83.6 MAXIMUM SPEEDS PERMITTED AND INSTRUCTIONS FOR HANDLING SPECIAL EQUIPMENT**

MAXIMUM AUTHORIZED SPEED FOR:

**Locomotive and car servicing tracks ..... Walking Speed**

**Walking speed is not to exceed ..... 4 MPH**

Passenger Trains, when authorized by Track Warrant or Track Bulletin ..... 59 MPH

Freight and Mixed Trains ..... 49 MPH

Trains handling combination freight and passenger equipment will not exceed speed prescribed for freight trains.

Auxiliary tracks, unless otherwise provided ..... 10 MPH

Through turnouts, unless otherwise provided ..... 10 MPH

**Through siding Turnagain ..... 25 MPH**

**Through siding and north siding turnout Campbell ..... 25 MPH**

**Through MP 109.5 Crossover and turnouts ..... 25 MPH**

**Through South Leg Airport Wye and turnout, MP 110.2 ... 25 MPH**

**Through North Leg Airport Wye and turnout, MP 110.58. 25 MPH**

**Anchorage North Yard Lead between:**

**Switch MP 115.4 and MP 117 crossover ..... 20 MPH**  
**Between MP 117 Crossover and Switch MP 119.8 ..... 25 MPH**

Through turnout MP 115.4 ..... 15 MPH

Through turnouts and crossover MP 117 ..... 15 MPH

Through turnout MP 119.8 ..... 25 MPH

Through junction turnout at Portage ..... 15 MPH

**Through sidings and siding turnouts: Pittman; Willow; Sunshine; Chase; Susitna; Hurricane; Summit; and Bear Creek — EXCEPT: Trains exceeding 100 tons per operative brake\* (excluding passenger trains) and trains handling loaded petroleum tank cars ..... 15 MPH**

SD70MAC over bridge 33 ..... 10 MPH

Railcars equipped with friction bearings ..... 35 MPH

Railcars equipped with friction bearings must not be moved in any revenue train without authorization from the Superintendent of Transportation.

Southward trains, except passenger trains, exceeding 100 tons per operative brake\* must not exceed the following speed restrictions:

**MP 112.0 to MP 111.7 ..... 15 MPH**

**MP 121.3 to MP 115.5 ..... 25 MPH**

MP 297.0 to MP 292.1 ..... 25 MPH

MP 279.7 to MP 270.3 ..... 25 MPH

MP 269.2 to MP 266.0 ..... 25 MPH

Trains passing occupied camp cars on auxiliary tracks immediately adjacent to the main track must not exceed 30 MPH.

Employees must not occupy the locomotive walkway at speeds greater than 25 MPH.

If speed authorized by Track Bulletin or Track Warrant is greater than speed prescribed for certain trains, engines, or equipment the most restrictive speed will apply.

## System Special Instructions

---

THE MAXIMUM SPEED OF TRAINS HANDLING EQUIPMENT INDICATED BELOW WILL BE AS FOLLOWS, UNLESS OTHERWISE PROVIDED:

Locomotive Crane No. 106 and 107 ..... 25 MPH

Locomotive Cranes No. 108, 109, 110 and 111 ..... 35 MPH

Locomotive Cranes must have their booms trailing when handled in trains, unless otherwise authorized.

Spreaders No. 7, No. 8, or No. 9 ..... 35 MPH

Spreaders must face in direction of travel when handled in trains. Spreaders in work train service may be handled in either direction. If handled with plow backwards, wings must be secured and movement authorized by Maintenance of Way operator.

Air dump cars, series ARR 15000 through ARR 15799, when loaded to car's capacity ..... 35 m.p.h.

Passenger trains handling cars equipped with three-axle trucks must position a crew member where they can closely observe these cars while moving through the following curves: 154, 269B, 284, 353A, 353B, 354D, 357C, 357D, and 411A (refer to track chart for exact locations).

**\*To figure tons per operative brake divide trailing tonnage by number of cars.**

### 83.7 SWITCH ALIGNMENT

Switches with yellow/green aspects may be left lined in either position after use.

**Switch machines, installed before the train dispatcher has the ability to control them, are considered hand-operated switches, and all rules governing hand-operated switches apply to them. These switches will be equipped with illuminated switch targets, and/or reflectorized targets affixed to the hand throw lever, until the signals governing movements over the switch are operational. The selector lever on these switches must be left locked in the HAND position.**



## **83.8      DERAILS**

### **EXCEPTION TO OPERATING RULE 8.20:**

When a track protected by a derail has no cars or equipment left standing on such track, derails will be left in the non-derailing position.

This exception will exclude derails in Anchorage (including Fort Richardson). Except when changed to permit immediate movement, derails at these locations must be set in the derailing position, unless otherwise provided for by Terminal Superintendent Bulletin.

## **83.9      SWITCHING/TRAIN MAKEUP RESTRICTIONS**

Crews handling TTWX cars must ensure the ramps are locked and secured in the upright position before coupling or initiating movement.

Hopper cars equipped with rotary couplers (TNM, HPJX, CEFX, **ARR 16400 series**) must not be handled in trains with their rotary coupler ends together (indicated by colored stripes).

When handling empty cars seventy-five (75) feet or longer, or TOFC/COFC cars loaded with empty trailers/containers, these cars will be handled on the rear portion of the train whenever possible. Cars in excess of seventy-five (75) feet in length must not be coupled to a car forty (40) feet or less in length while handled in trains.

In switching, cars are not to be coupled at a speed more than four miles per hour.

Kicking, dropping, or allowing rail cars to move under their own momentum is prohibited.

Passenger coaches must not be coupled to cars equipped with double-shelf couplers.

### **83.10    LOADING AND HANDLING HEAVY EQUIPMENT**

Trains handling cranes, shovels, and similar equipment set up with or without boom attached, must be handled under instructions issued by the Customer Service Department.

Customer Service will ensure proper placement of steel underframe flat cars of not less than 100,000 pounds capacity for loading of equipment specified above. It will be the responsibility of the Mechanical Department to inspect and accept such loads, advising Customer Service of acceptance, giving car number and maximum speed at which car may be moved. It will be the responsibility of Customer Service to see that no loads such as specified above will be placed in trains for movement until they have been accepted by the Mechanical Department and the Train Dispatcher has been notified of any speed restrictions.

Equipment with boom attached must be loaded with boom trailing unless approval from a Transportation Supervisor is obtained for movement in forward position. Conductors handling loads with boom in forward position, except on work trains, will be authorized to do so by message from the Transportation Supervisor.

When equipment as specified above is picked up at other than inspection points or terminal, train crew will take precautions to ensure safe handling to destination or next inspection point.

Dozers loaded to depressed center cars should be centered on car and must have the blade of the dozer placed on elevated portion of the car and blade properly secured for movement in train.

### **83.11    SETTING OUT CARS**

All cars handled in trains will be set out at destination shown on work message. If, at any time, it is necessary to do otherwise, permission must **FIRST** be obtained from the Train Dispatcher giving specific reasons why set out cannot or should not be made.

When setting out cars at intermediate stations, they will be spotted to proper location at time of set out. When possible, cars will be spotted not less than 400 feet from clearance point of switch.

Conductor will use Set Out and Pickup Report form to report cars set out or picked up at intermediate stations. All available information must be included.

**BADORDERSHIPMENTS:**

If shipment is set out en route due to defect, conductor will notify the Train Dispatcher of the car number, contents, shipper, consignee, and detailed description of defect. The Train Dispatcher will then notify the appropriate Terminal Superintendent and the Customer Service Department to make arrangements to notify the Mechanical Department, shipper and consignee that their car has been set out and give approximate time the car will be moved to destination.

When loads are bad ordered at terminals, the Terminal Superintendent will notify Customer Service, who, in turn, will notify the shipper and consignee.

**DEFECTIVECARREPORTS:**

These reports must be submitted even if no defects are noted. If no defects are noted, this must be reflected on report.

Passenger Trains: Form 22-1001P “Coach Inspection Report” must be completed for each coach by the completion of each trip, and left in a conspicuous location either in the dome car office, baggage car, or in a coach if there is no baggage car.

Other Than Passenger Trains: Conductors on freight trains will fill out a copy of Form 22-0156P “Conductor’s Report of Defective Cars on Trip” for any defective cars on their trip. This form is to be submitted to the employee in charge at Anchorage or Fairbanks or, in the absence of an employee in charge, sent to the trains destination.

## **83.12 EXCESSIVE HEIGHT CARS AND LOADS**

When handling excessive height cars or loads, especially passenger equipment, high cube box cars, loaded bi-level and tri-level auto racks, high cube trailers on flat cars (TOFC), or excessive height loads into warehouses, shops, freight house sheds or other buildings, the movement of this equipment or load must be protected to

prevent damage to building, overhead equipment, roof projections and vehicles loaded on cars being spotted.

When operating conditions require the placing of this equipment to areas of close or restricted clearance, all concerned must protect the movement to prevent accident or injury.

### **83.13 CLEARANCE OF HIGH, WIDE AND HEAVY LOADS**

For clearance of the following types of loads and cars, contact the Clearance Coordinator through the Customer Service Department:

- Loads and cars exceeding the dimensions shown in Special Instructions.
- Loads and cars longer than 90 feet over strikers.
- Double or triple loads.
- Loads with overhangs beyond the end of car.
- Loads with unequal distribution of weight on trucks.
- Cars exceeding the gross weight limits shown in Special Instructions or the stenciled capacity of the car.
- Shipments having a combined center of gravity of car and lading exceeding 90 inches above top of rail.

*Teamwork is our  
game plan for  
accident prevention.*

**83.14 LOADING CLEARANCE DIAGRAMS**

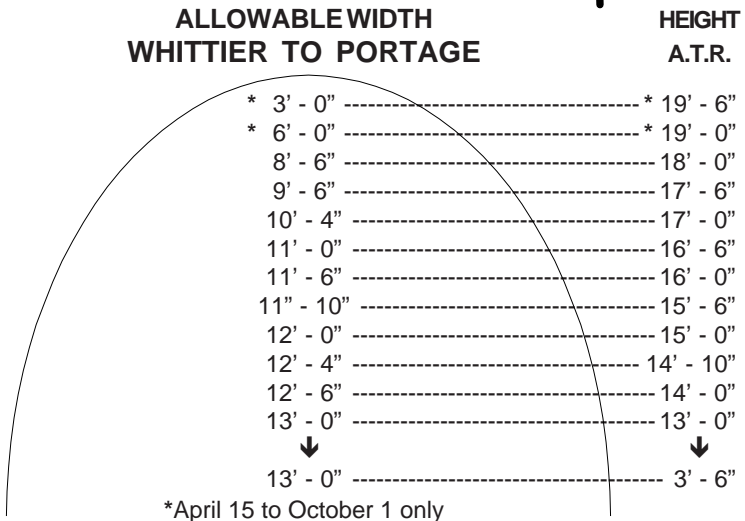
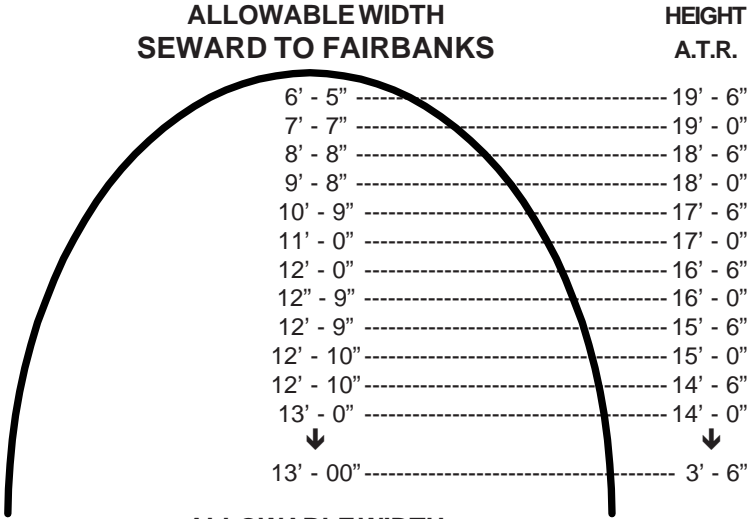

**MAXIMUM LOADING DIAGRAM  
FOR SINGLE CARLOADS**

Above diagrams are for single carloads without overhangs beyond end of car and are based on cars with a length not exceeding 90 feet over strikers, with truck centers not exceeding 66 feet, and overhangs not exceeding 12 feet.

All loads exceeding the above limits must be cleared and coordinated through the Customer Service Department.

### 83.15 HEAVY LOADS

Maximum gross weight of car and lading in pounds on all subdivisions in 263,000 lbs.

Maximum gross weight of car and lading based upon uniformly loaded 4-axle spacing with combined center of gravity not more than 90 inches above top of rail. Gross weight of 263,000 pounds applies to 4-axle cars with truck centers of 28 feet or greater. Four-axle cars with truck centers less than 28 feet are restricted to 240,000. Loads of greater dimensions or weights may be moved by special arrangement coordinated through the Customer Service Department, or as outlined in section 83.13.

### 83.16 STANDARD HOPPER CAR LOADING CAPACITY

The following will govern the maximum loading limits of hopper cars used in coal service:

Hopper Series	Tare Weight (approximate)	Gross Weight (railcar and contents)
ARR 7100 - 7199	57,600	215,000
ARR 14301 - 14349	49,600	215,000
ARR 14400 - 14449	53,800	215,000
ARR 14809	48,900	215,000
ARR 16000 - 16075	64,700	263,000
ARR 16100 - 16180	63,000	263,000
ARR 16200 - 16255	50,800	263,000
<b>ARR 163XX - 163XX</b>	<b>63,000</b>	<b>263,000</b>
<b>ARR 164XX - 164XX</b>	<b>50,800</b>	<b>263,000</b>
<b>ARR 165XX - 165XX</b>	<b>68,000</b>	<b>263,000</b>
CEFX 61976 - 62038	65,700	263,000
HPJX 40515 - 40612	64,800	263,000
JAIX 99116 - 99145	65,700	263,000
TNM 20000 - 20104	65,000	263,000

- No overloaded hopper car can exceed 268,000 pounds.
- No more than five overloaded hopper cars in the train can exceed 263,000 pounds.

Under these parameters, train can proceed without restriction. If these limits are exceeded, notify the Train Dispatcher before proceeding.

**The following will govern the maximum loading limits of hopper cars used in commercial aggregate service:**

Hopper Series	Tare Weight (approximate)	Gross Weight (railcar and contents)
ARR 16000 - 16075	64,700	264,700
ARR 16100 - 16180	67,500	267,500
CEFX 61976 - 62038	65,700	265,700
HPJX 40515 - 40612	64,800	264,800
JAIX 99116 - 99145	65,700	265,700
TNM 20000 - 20104	65,000	265,000

**In addition:**

- No hopper car can be loaded with more than 100 tons of aggregate.
- Aggregate material must be evenly distributed throughout the car.
- No hopper car can exceed 268,000 pounds.

Under these parameters, train can proceed without authority or restriction. If these limits are exceeded, notify the Train Dispatcher before proceeding.

### **83.17    LOADING PLACEMENT OF TOFC CONTAINERS**

On three-hitch fifth-wheel-equipped flat cars, when loading two trailers, they must be positioned either on the end stands or both trailers on the end of the car in the direction of train movement. When loading a single trailer, it must be positioned at the end of the car in the direction of train movement.

On two-hitch fifth-wheel-equipped flat cars, single trailers must be positioned at the end of the car in the direction of train movement.

When loading trailers which have the commodity wrapped with a protective covering, the trailer should, if possible, be located with the hitch secured on a stand in the direction of train movement to help prevent the wrapping material from loosening.

## 83.18 SLIDE ZONES

Beginning of slide zone will be indicated by signs reading “BEGIN SLIDE ZONE (No.)”, located on right side of track in direction of approaching train. End of slide zone will be indicated by sign reading “END OF SLIDE ZONE (No.)”, located to the left of track in direction of approaching train.

Advance slide zone warning signs will be placed one half mile in advance, **except southward advance sign for slide zone 11 is placed seven tenths of a mile in advance**, of slide zone sign located on right side of track in direction of approaching train and will be indicated by an international orange sign with the number of the slide zone in black lettering.

When conditions require, track warrant or track bulletin will be issued advising which slide zones are in effect. On receipt of these instructions, speed of train must not exceed 15 MPH. This restriction is only applicable to the portion of the slide zone where visibility is restricted. These restrictions end when the leading end of the train reaches the end of slide zone sign, or no obstructions can be seen to the end of slide zone sign.

Advance permission may be obtained from the train dispatcher to back away from a slide over the tracks when operating in designated avalanche areas (Slide Zones 18 through 83 and F7). In order to clear the slide area, train may begin the back up movement in accordance with Rule 6.6 (Picking Up Crew Member), and may then continue in accordance with Rule 6.4 (Reverse Movement). Once train is stopped clear of the chute crew is to await further instructions.

### SLIDEZONES

<u>No.</u>	<u>Between</u>	<u>Reason</u>
11	MP 11.3 & 11.6	Rock/Snow
16	MP 16.2 & 16.6	Snow*
18	MP 17.8 & 18.5	Snow*
21	MP 20.6 & 21.2	Snow*
43	MP 42.6 & 43.62	Snow*
49	MP 48.8 & 49.8	Snow*
51	MP 51.3 & 52.9	Rock/Snow/Brush*
53	MP 52.9 & 53.6	Snow*
F 7	MP F 6.73 & F 6.91	Snow*
68	MP 67.2 & 68.1	Snow*



70	MP 69.2 & 70.1 (MP 69.9 a.k.a. Centerline)	Snow*
72	MP 71.2 & 72.6 (a.k.a. Kern btw MP 71.2 and MP 71.5)	Snow*
76	MP 75.6 & 80.6 (MP 78.3 a.k.a. Whisky Gulch)	Snow*/Rock/Mud
<b>78</b>	<b>MP 78.0 &amp; 78.1</b>	<b>Rock/Snow*</b>
83	MP 82.4 & 83.9	Snow*
87	MP 86.9 & 87.4	Rock/Mud
224	MP 224.7 & 224.9	Sand/Brush/Rock/Snow
233	MP 232.8 & 233.1	Mud/Rock/Brush/Snow
236	MP 236.5 & 237.0	Mud/Rock/Brush/Snow
237	MP 237.0 & 238.0	Mud/Rock/Brush/Snow
238	MP 238.0 & 239.0	Mud/Rock/Brush/Snow
239	MP 239.7 & 240.0	Mud/Rock/Brush/Snow
240	MP 240.0 & 241.1	Mud/Rock/Brush/Snow
241	MP 241.5 & 241.6	Mud/Rock/Brush/Snow
244	MP 243.6 & 244.1	Mud/Rock/Brush/Snow
246	MP 246.2 & 247.0	Mud/Gravel/Rock/Snow
247	MP 247.0 & 247.9	Mud/Gravel/Rock/Snow
254	MP 253.4 & 254.3	Mud/Rock/Snow
255	MP 255.5 & 255.8	Rock/Snow/Brush/Trees
259	MP 258.7 & 260.05	Rock/Snow/Brush/Trees
266	MP 266.1 & 266.3	Gravel/Rock/Snow
269	MP 269.2 & 269.9	Rock/Brush/Snow
286	MP 285.95 & 287.0	Rock/Dirt/Brush/Snow
288	MP 287.9 & 288.05	Snow
294	MP 293.1 & 294.3	Snow/Mud/Brush/Trees/Rock
321	MP 320.9 & 321.95	Rock/Mud/Gravel/Brush
325	MP 325.6 & 325.75	Rock/Gravel
327	MP 327.1 & 327.8	Rock/Mud
328	MP 328.8 & 329.0	Rock
332	MP 332.5 & 332.7	Snow/Trees/Brush
334	MP 334.05 & 334.15	Rock
336	MP 335.9 & 336.2	Rock
341	MP 340.8 & 341.7	Rock/Trees/Brush/mud at n/e
371	MP 371.5 & 371.7	Rock/Mud
383	MP 382.4 & 383.1	Rock/Gravel
384	MP 384.2 & 384.6	Rock/Gravel
415	MP 414.5 & 415.0	Rock

\* designates avalanche areas.

Only the Assistant Vice President, Maintenance, or an Avalanche Technician can permit a train to proceed through a downed avalanche.

### **83.19 AVALANCHE DETECTION SYSTEM**

An avalanche detection system is in service at Slide Zone 72. The detector is located near the top of the avalanche chute between MP 71.2 and MP 71.5, identified in warning message as “Kern”. Various instruments are used by this detector to determine if an avalanche has released. Once an avalanche is detected the detector sends a signal to the radio base station, located at Portage, which will then broadcast an emergency warning message, “Possible Avalanche at Kern”, on radio channel 2. It takes approximately 50 seconds, once an avalanche has been detected and the warning message begins broadcasting, for the avalanche to potentially reach the main track. Trains and on-track equipment receiving this emergency broadcast must, if possible, stop movement before entering Slide Zone 72 between MP 71.2 and MP 71.5. After stopping, and after at least 50 seconds have passed, movement may continue at restricted speed, and in compliance with Slide Zone restrictions, until the main track in Slide Zone 72 is seen to be clear. Trains and on-track equipment receiving this emergency broadcast which cannot stop movement before entering the avalanche chute between MP 71.2 and MP 71.5 must take action to ensure that an occupied locomotive, coach, caboose or the on-track equipment will not be passing through, or end up stopped in, the avalanche chute. If necessary to stop notify the train dispatcher, who will contact an avalanche technician, for further instructions.

### **83.20 MOVEMENT OVER BRIDGES**

The speed of trains must be controlled before crossing the following bridges so that no air application, and only minimal dynamic braking, will have to be made while train is upon these bridges, except in case of emergency or consistent with safe train handling:

- Bridge 146.4 ----- Knik River
- Bridge 284.2 ----- Hurricane Gulch
- Bridge 347.4 ----- Riley Creek
- Bridge 413.7 ----- Tanana River

---

## 83.21 DRAGGING EQUIPMENT DETECTORS AND/OR DEFECT DETECTORS

### General Information

Dragging equipment and/or defect detectors will notify train crew of any detected defect and/or dragging equipment via radio communication after train has cleared the detector circuit.

When defects are noted, the axle number of the defect will be given by type “B” and “C” detectors; type “A” and “D” do not give axle number of defect. Axle locations are counted from the head-end of the train, including the locomotives. For the purpose of this section, locomotive axles will be counted the same as cars. If inspection does not reveal a defect at the axle indicated, inspect 12 axles forward and 12 axles to the rear of the indicated axle. Inspect all 12 axles in each direction, even if a defect is found before reaching the twelfth axle.

When a detector alarm requires inspection, if applicable, inspect the side of the train in the message.

Trains receiving notification of hot bearing will use a 200° temperature indicator stick, if available, to assist in determining whether the car must be set out. If the temperature indicator stick melts after contacting the indicated hot bearing, the car must be set out.

Connecting or relieving crews must be advised of any unusual occurrences encountered at detector locations passed en route by inbound crew.

A sign reading “DD” may be attached to flanger boards preceding some detectors to alert train crews to monitor channel 4.

### Detector Malfunction (including no communication)

Detectors may communicate “detector malfunction” in the following circumstances:

- Power failure.
- 7 or more defects of the same type.
- Train movement through detector at approximately 8 m.p.h. or less.

Trains receiving radio notification of “detector malfunction” or there is no communication after passing detectors may continue to the next detector location, except under the following conditions:

- Train will not pass a second “A”, “B”, or “C” detector location or will not receive an inspection before entering a

terminal (i.e.; MP 123 detector malfunctions for southbound train and car inspector not in position to give “roll-by” inspection at north end of yard, then crew must stop and inspect train before entering Anchorage terminal).

- An alarm tone sounds while passing the detector.
- Detector advises there is dragging equipment.
- Southward trains must stop and inspect train for any abnormal operation of detectors located at MP 417, MP 356.5, MP 348.2, and MP 75.
- Northward trains must stop and inspect train for any abnormal operation of detectors located at MP 185.2, MP 225.7, MP 281.5, and MP 405.

Trains receiving radio notification of “detector malfunction” or no communication after passing a second detector must stop and inspect train.

Notify Train Dispatcher any time a detector gives “detector malfunction” or “call maintainer” report.

### **83.21.1 Type “A”, Dragging Equipment Detector.**

- Dragging equipment detectors detect any equipment dragging on top of ties.
- Type A Detector locations are shown on the Station Columns.
- Operates on Channel 4

### **83.21.2 Type “B”, Dragging Equipment/Hot Bearing Detector.**

- Dragging equipment/hot bearing detectors detect any equipment dragging on top of ties and /or any hot bearings (ambient temperature plus 172° Fahrenheit or 120° Fahrenheit temperature variance between ends of same axle) and/or any hot wheels (600° Fahrenheit).
- These detectors will communicate total axle count after train clears the circuit.
- Type B Detector locations are shown on the Station Columns.
- Operates on channel 4

---

**83.21.3 Type “C”, Dragging Equipment/Hot Bearing/Hot Wheel/High or Wide Clearance Detector.**

- Dragging equipment/hot bearing/hot wheel/high or wide clearance detectors detect any equipment dragging on top of ties and/or any hot bearings (ambient temperature plus 172° Fahrenheit or 120° Fahrenheit temperature variance between ends of same axle) and/or any hot wheels (600° Fahrenheit) and/or any high or wide clearances (19’ 4” high and/or 13’ 6” wide).
- Type C Detector locations are shown on the Station Columns.
- Type C Detectors use photo-optic sensors to detect high or wide clearance defects. These wide clearance detection devices are located 6’ 9” from the track center.
- Trains crews receiving radio notification, “Clearance defect near axle \_\_\_\_\_” followed by, “Detector Malfunction” at these detectors must stop and inspect their train.
- Operates on Channel 4
- Trains receiving notification of “clearance defect” within the locomotive consist or within a passenger, unit hopper or tank train, may continue without inspection.

**83.21.4 Type “D”, Dragging Equipment Detector.**

- Dragging equipment detectors detect any equipment dragging on top of ties.
- Type “D” detectors operate on the applicable road channel at the location of the detector and will only communicate if activated by dragging equipment. Once this type detector is activated, it will not be operational again until reset by a signal maintainer.
- All Type “D” defect detector alarms are to be reported to the train dispatcher.
- Type “D” detector locations are not shown on Station Columns.

**Detector Type, Location and Operating Radio Frequency Chart:**

Location	Name	Channel	A	B	C	D
456.2	Dome	4		●		
417.7	North Nenana	4		●		
413.0	413 Nenana	1				●
405.4	MP 405	4			●	
370.1	Ferry	4		●		
357.5	MP 357.5	1				●
357	MP 357	1				●
356.4	Garner	4	●			
<b>355</b>	<b>MP 355</b>	7				●
353.9	MP 353.9	7				●
353.5	MP 353.5	7				●
353.1	Moody	4	●			
<b>351.3</b>	<b>MP 351.3</b>	7				●
350.4	Cascade	<b>4</b>	●			
348.9	MP 348.9	7				●
348.2	Denali Park	4		●		
345.0	MP 345.0	7				●
339.7	MP 339.7	7				●
332.9	MP 332.9	7				●
328.1	MP 328.1	7				●
322.5	MP 322.5	7				●
319.4	Cantwell	4			●	
294.8	MP 294	7				●
290.5	Honolulu	4	●			
286.5	MP 286	7				●
281.1	Hurricane	<b>4</b>		●		
276.0	MP 276	<b>7</b>				●
270.4	MP 270	<b>1</b>				●
261.0	Gold Creek	4	●			
258.5	MP 258	<b>1</b>				●
252.0	MP 252	<b>1</b>				●
225.7	Talkeetna Hwy	4		●		
206.2	Parks Highway	4		●		
185.2	Willow	4			●	
164.3	Schrock-Pittman	4		●		
145.5	Old Glenn Hwy	4		●		
123.0	Loop Road	4		●		

104.6	Ocean View	4		●		
88.7	Indian	4		●		
75.0	Girdwood	4			●	
63.0	Portage	4		●		
42.2	Grandview	4	●			
29.4	Moose Pass	4		●		
18.4	Primrose	4		●		
14.3*	Snow River	4	●			
G4.2	MPG 4.2	4				●
G3.6	MPG 3.6	4				●
G1.5	MPG 1.5	4				●

\*Detector MP 14.3, Snow River, out of service until further notice. Trains are not required to inspect after passing this detector.

### 83.22 HIGHWAY CROSSING SIGNALS

Automatic crossing signals on auxiliary tracks at the following locations are activated with motion detectors. These signals will give a thirty-second warning when a train or engine is moving at 10 mph:

- Arctic Blvd. .... MP 109.4
- Whitney Rd. at Post Rd. Psgr Main ..... MP 115.3
- Davis Highway ..... MP 119.1
- Knik Goose Bay Rd. .... MP 159.9
- Old Willow Rd. .... MP 185.5

Automatic crossing signals on auxiliary tracks at the following locations will not be activated until the train or engine is within approximately 30 feet of the crossing:

- Klatt Rd. .... MP 105.6
- 100<sup>th</sup> Ave.\* ..... MP 106.7
- N. Cordova ..... Psgr Main MP 114.7
- N. Ingra ..... Psgr Main MP 114.9

\*Can also be operated manually.

Crossing signals at C Street, MP 114.3, have been automated for movements on Passenger Main only. All movements over auxiliary tracks (team tracks) must be protected by manual start button lo-

cated on the side of control cabinet. The ON-OFF switch is located inside box locked with switch lock. When ON switch is activated, a yellow strobe light located on top of control cabinet will flash to indicate the crossing signal is in manual ON and will continue to flash until OFF button is depressed.

**Trains entering the main track at NSS Campbell, not otherwise governed by Rule 6.32.2, must not foul highway crossing MP 110.75 until the warning device has been operating long enough to provide warning and the crossing gates are fully lowered.**

**Trains entering the main track at SW MP 115.4, not otherwise governed by Rule 6.32.2, must not foul highway crossing MP 115.3 until the warning device has been operating long enough to provide warning and the crossing gates are fully lowered. There is a sign reading “Crossing Start” at the south end of the North Yard Lead track indicating the beginning of the crossing signal circuit. Equipment must not be left standing inside this track circuit, as it will cause a short warning at the crossing for a southbound train on the main track.**

Crossing signals for Post Rd. at 1<sup>ST</sup> Avenue, K&L Spur, and N.C. Machinery Spur can only be operated manually.

**Trains moving on Wasilla siding, not otherwise governed by Rule 6.32.2, must not foul Knik-Goose Bay Road highway crossing, MP 159.9, until the warning device has been operating long enough to provide warning and the crossing gates are fully lowered.**

**Unless movement is delayed a sufficient time to allow a minimum of twenty (20) seconds advanced warning of automatic crossing signals, crossing must be protected in accordance with GCOR Rule 6.32.2.**

Anything that affects the operation of railroad crossing signals such as broken bonds, lights out, damage to battery boxes, etc., must be reported immediately to the Train Dispatcher.

No one will alter, modify, turn off, or in any other way make changes to the operation of an automatic or manually operated signal device without the specific authority to do so from the Supervisor, Signaling.



Upon discovery or notification of a crossing signal malfunction, any employee must immediately notify the Train Dispatcher by the quickest means available. The Train Dispatcher must notify the Special Agent or police having jurisdiction over the crossing and each train prior to its arrival at the affected crossing.

Trains or equipment must not cause unnecessary activation of highway crossing signals. If necessary to stop at a highway crossing, stop must be outside of the island circuit, approximately 100 feet on either side of the crossing. This will allow the signal to reset after approximately 18 seconds. Once the train begins to move again, the crossing must not be occupied until the crossing signal system has had sufficient time to reactivate and provide warning to highway traffic, and, if equipped, the crossing gates are fully lowered.

Exception: Trains or equipment must not stop in the approach to the following highway crossing signal circuits because they are not equipped with motion detectors and will not reset:

- MP 117.15 ..... Post Road
- MP 279.65 ..... Hurricane
- MP 305.50 ..... Broad Pass
- MP 313.96 ..... Summit
- MP 392.96 ..... Clear Site
- MP G 1.88 ..... Old Steese
- MP G 1.92 ..... New Steese
- MP G 5.07 ..... Neely Road
- MP G 9.31 ..... Bradway Road
- MPG 16.30 ..... 5th Ave.
- MPG 17.55 ..... Laurence Road

### **83.23 GRADE CROSSING/HIGHWAY CROSSING CROSS REFERENCE**

<u>ARRC Mile Post Location</u>	<u>Highway Location</u>
2.3 ARR Roundhouse Rd.	East of Seward Hwy MP 2.2
2.9 Airport Road	East of Seward Hwy MP 2.8
3.5 Nash Road	East of Seward Hwy MP 3.5
4.3 Subdivision Rd.	Off Nash Rd.
5.2 Subdivision Rd.	East of Seward Hwy MP 5.2

## System Special Instructions

---

6.3	Lake Drive	East of Seward Hwy MP 6.3
6.7	Bear Lake Road	East of Seward Hwy MP 6.7
12.2	Seward Hwy Overpass	Seward Hwy MP 12, Divide
14.3	Seward Hwy Overpass	Seward Hwy MP 14, Snow River
18.2	Seward Hwy Overpass	Seward Hwy MP 18, South Kenai Lake
23.7	Crown Point Crossing	Seward Hwy MP 23.4
29.2	Moose Pass	Seward Hwy MP 29
62.9	Portage Glacier Road	East of Seward Hwy MP 79
64.66	Portage Parking Lot	Seward Hwy MP 80
74.7	Alyeska Hwy Overpass	Girdwood, 3 mi. East of Seward Hwy
75.0	DOT Maintenance Rd.	Girdwood, 3 mi. East of Seward Hwy
77.7	Utility Maintenance Rd.	East of Seward Hwy
80.9	Seward Highway Underpass	Seward Hwy MP 95.9
102.8	Rabbit Crk Rifle Range	Seward Highway MP 117
104.6	Ocean View Drive	West of Seward Highway
105.3	East 120 <sup>th</sup> Avenue	West of Seward Highway
105.6	Klatt Road	West of Seward Highway
106.2	O'Malley Dr. Overpass	West of Seward Highway
<b>106.45</b>	<b>East 104<sup>th</sup> Avenue</b>	<b>West of Seward Highway</b>
<b>106.67</b>	<b>East 100<sup>th</sup> Avenue</b>	<b>West of Seward Highway</b>
107.7	Dimond Blvd. Overpass	West of Seward Highway
108.2	67 <sup>th</sup> Avenue Overpass	West of Seward Highway
108.8	Raspberry Rd.	Off C St.
108.9	C Street	North of Raspberry Road
109.4	Arctic Blvd.	South of Int'l Airport Road
110.0	Int'l Airport Overpass	East of Minnesota Drive
110.4	Minnesota Dr. Overpass	North of Int'l Airport Road
110.7	44 <sup>th</sup> Avenue	West of Minnesota Drive
111.0	Spenard Road	West of Minnesota Drive
111.3	36 <sup>th</sup> Avenue	West of Minnesota Drive
111.7	Northern Lts. Overpass	West of Minnesota Drive
<b>114.4</b>	<b>Anchorage Depot</b>	<b>1<sup>st</sup> and C Street</b>
114.7	North Cordova	1 <sup>st</sup> Ave./Warehouse Ave.
114.9	North Ingra	1 <sup>st</sup> Ave./Warehouse Ave.
115.3	Whitney Road	West of Post Road
117.1	Post Road	North EAFB Post Road Gate
<b>119.8</b>	<b>Davis Highway</b>	<b>East of EAFB Spur Road</b>

122.9	Loop Road	Otter Lake, Fort Richardson
128.0	Artillery Road	West of Eagle River on Fort Richardson
133.2	Bible Camp Road	A.k.a. Beach Lake, West of S. Birchwood Loop, : mi. North of Glenn Hwy MP 17.2
136.3	North Birchwood Road	1.7 mi. North of Glenn Hwy MP 21 Near Birchwood Airport
141.9	Eklutna Village	2 mi. West of Glenn Hwy MP 26.3
142.35	Glenn Hwy Overpass	Glenn Hwy MP 26.8
145.5	Old Glenn Highway	¾ mi. East of Glenn Hwy MP 29.6
151.6	Glenn Highway	Glenn Hwy MP 34.9 .1 mi. South of Glenn/Parks Hwy Junction
155.3	Abby Boulevard	West of Fairview Loop, Parks Hwy MP 38
156.2	Fairview Loop Road	12 mi. West of Parks Hwy MP 38
157.1	Jude Road	Sewer Plant
158.6	Glenwood Road	Palmer Wasilla Highway
159.9	Knik-Goose Bay Road	100' West of Parks Hwy MP 42.2
160.8	Snyder Road	100' West of Parks Hwy MP 44
161.2	Lucille Lane (Halleah)	100' West of Parks Hwy MP 45
162.3	Church Road	600' West of Parks Highway MP 46
164.2	Parks Highway	Parks Highway MP 46.6
166.3	Pittman Road	East of Parks Hwy MP 48.7
167.3	Meadow Lakes	2 mi. East of Parks Hwy MP 49.5
171.28	Parks Highway	East of Parks Highway MP 54.7
173.0	Houston/Parks Hwy	Parks Highway MP 56.4
182.7	Whites Underpass	Parks Highway MP 66.5
<b>185.5</b>	<b>Old Willow Road</b>	<b>East of Parks Highway</b>
186.9	Hatcher Pass Road	Parks Highway MP 71.2

## System Special Instructions

---

193.5	Kashwitna Road	Just North of Parks Hwy MP 78
<b>198.0</b>	<b>Kashwitna Estates</b>	<b>East of Parks Highway MP 83 to end of road then turn right.</b>
202.94	Hidden Hills Access Rd.	.3 mi. East of Parks Hwy MP 88
206.2	Parks Highway	Parks Highway MP 91.7
209.5	Lankford Farm	2 mi. West of Parks Hwy MP 95.5
214.0	Sunshine/Parks Hwy	Parks Highway MP 100.4
225.7	Talkeetna Road	Talkeetna Road MP 13.3
226.4	FAA Road	Off Talkeetna Road
279.6	Hurricane/Parks Hwy	Parks Highway MP 169
<b>298.0</b>	<b>Gold Mine Road</b>	<b>Parks Highway MP 186.8</b>
305.5	Broad Pass/Parks Hwy	Parks Highway MP 194.3
313.9	Summit/Parks Hwy	Parks Highway MP 202.1
319.0	Cantwell	East of Parks Hwy MP 209.9
345.0	Parks Highway	Parks Highway MP 235.1, Just South of Denali Park
346.6	Parks Hwy Overpass	Parks Highway MP 236.7
348.2	Denali Park Road	1 mi. West of Parks Hwy MP 237.3
360.0	Healy Underpass	Healy Spur Road
362.1	Usibelli Tipple Access	
371.1	Ferry Road	.1 mi. North of Nenana River Crossing
386.2	Rex/Parks Highway	Parks Highway MP 276.
388.0	388 Pit	East off Parks Hwy MP 386.5 about 1¾ mi. to pit
392.9	Clear AFB Road	2 mi. West of Parks Hwy MP 283
395.1	Anderson Road	Anderson Hwy (Off Clear AFB Road)
405.0	405 Detector	West of Parks Hwy MP 298.9 towards radio tower
411.31	Nenana Underpass	Parks Highway MP 304.5
415.4	FAA Road	A.k.a. North Nenana. East off Parks Hwy MP 306.2
416.1	Nenana Dump Road	Parks Hwy MP 306.8 (locked city gate)

417.7	Monderosa(Parker's Patch)	Parks Highway MP 308.8
420.0	Agricultural Access	A.k.a. Manley. West off Parks Hwy MP 310.8 to cleared area is MP 420, another ½ mi. is Manley siding
422.7	Runyon Crossing	West of Parks Hwy MP 314.5 ("Runyon" sign on mailbox) over Little Gold Stream Bridge. .4 mi. south of bridge turn right on 1st major gravel rd., then ¾ mi. to tracks
443.4	Standard Ck. Logging Rd.	West of Parks Hwy MP 343 on Old Nenana Hwy 2 mi. to 1st major gravel rd, turn left, then 8 mi. to tracks
453.0	Martin Siding	Murphy Dome Rd., about 3 mi. past Dome over bridge, .4 up the hill, turn left on Cache Ck. Rd. for about 150 feet, then left to old road bed
456.2	Dome	MP 5.5 Murphy Dome Rd, turn left to stop sign and gate
459.8	Gold Mine Crossing	Sheep Ck. Rd. to Murphy Dome Rd., turn left, then about 1½ mi. to 1st major road on left (gravel pit on right), then ½ mi. to tracks
461.3	2 <sup>nd</sup> Sheep Creek Road	A.k.a. Goldstream. Take Sheep Creek Rd. west of Parks Hwy MP 355.8, past Ester crossing, turn left at stop sign, then past Happy crossing to next crossing
462.8	Happy/1 <sup>st</sup> Sheep Creek	Sheep Creek Rd. West of Parks Hwy MP 355.8 past Ester crossing, turn left at stop sign
465.5	W. Tanana/Gold Hill Rd.	A.k.a. Ester crossing (Old Sheep Ck.) West on Sheep Ck. Rd. off Parks Hwy to 1st road crossing.

466.1	Experimental Farm	Geist Rd. to Fairbanks St., turn right toward UAF, turn left on Tanana toward Sheep Ck. Rd. (runs parallel to tracks), take 1st dirt rd. to the left (before getting to UAF Experimental Farm)
467.7	University Avenue	University and Johannsen Expressway
470.3	Passenger Depot	Fairbanks

### **83.24 RADIO COMMUNICATIONS**

---

---

Dispatcher, Maintenance of Way, and Yard (except channel 6) radio frequencies all have 911 emergency call-in capability. Once activated, the radio will answer back with a short tone, followed by three beeps, then another short tone, acknowledging the call has been received by the dispatcher radio system.

---

---

#### **RADIOS**

Communications may be established on these channels as follows:

Channel 01	—	Train to Train/Alternate Dispatcher
Channel 02	—	Train to Dispatcher*#
Channel 03	—	Yard Operations
Channel 04	—	Gravel/Coal/Yard Operations
Channel 05	—	Yard Operations
Channel 06	—	Yard Operations
Channel 07	—	Train to Train/Alternate Dispatcher
Channel 08	—	Train to Dispatcher *#
Channel 09	—	Radio Telephone**
Channel 10	—	Radio Telephone**
Channel 11	—	Radio Telephone**
Channel 12	—	Maintenance of Way
Channel 13	—	Maintenance of Way
Channel 14	—	Maintenance of Way
Channel 15	—	Maintenance of Way
Channel 16	—	TOFC

\*See Section 83.25 for operation

\*\* See Section 83.26 for operation

# All communications in Whittier Subdivision tunnels must be on channel 2.

<b>RADIO COMMUNICATIONS</b>	
Seward to Portage	Channels 1 / 2
Whittier to Portage	Channels 1 / 2
Portage to Anchorage	Channels 1 / 2
Anchorage to MP 162	Channels 1 / 2
MP 162 to MP 223	Channels 7 / 8
MP 223 to MP 274	Channels 1 / 2
MP 274 to MP 356	Channels 7 / 8
MP 356 to Fairbanks	Channels 1 / 2

Signs are mounted at **MP 162, MP 223, MP 274, and MP 356** as a reminder to change radio channel.

Trains operating on main track, outside yard limit territory, which are communicating on other than channels 1 and 2 or 7 and 8, will also arrange to monitor the train to dispatcher or the train to train channels.

**Radio Approximate Coverage Map Follows:**

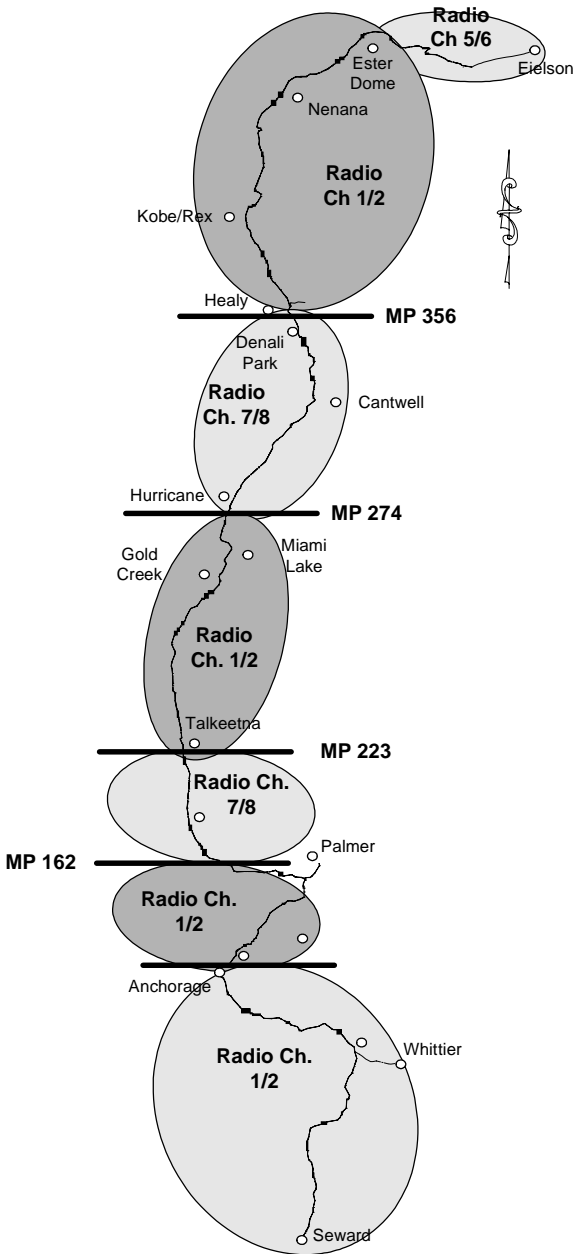



## 83.25 DISPATCHER CALL ON TOUCH PAD-EQUIPPED RADIOS

To call dispatcher enter two digit call code for area as shown below:

<u>Base Radio</u>	<u>Call Code</u>	<u>Base Radio</u>	<u>Call Code</u>
Seward .....	00	Talkeetna .....	03
Moose Pass .....	02	Talkeetna (use ch. 1) .....	03
Hunter .....	01	Gold Creek .....	04
Whittier .....	03	Gld Crk Alt (use ch. 1) .....	04
Whittier Tunnels .....	05	Hurricane .....	05
Portage .....	04	Cantwell .....	06
Anchorage South .....	05	<b>Carlo (Ch. 7) .....</b>	<b>03</b>
Anchorage Ch. 4 .....	00	Denali Park .....	01
Anchorage .....	00	Healy .....	00
<b>Wasilla (Ch. 7) .....</b>	<b>02</b>	Healy Ch. 4 .....	04
<b>Wasilla (Ch. 1) .....</b>	<b>02</b>	<b>Rex .....</b>	<b>05</b>
Houston .....	01	North Nenana .....	02
<b>Willow (Southward) .....</b>	<b>05</b>	Fairbanks .....	03
<b>Willow (Northward) .....</b>	<b>06</b>	Fairbanks Ch. 3 .....	03

NOTE: Both digits (include the preceding zero) must be used.

**The district 1 train dispatcher authorizes main track movements between Seward and Pittman, including the Whittier Subdivision. The district 2 train dispatcher authorizes main track movements between Pittman and Fairbanks. The telephone number to district 1 dispatcher is 265-2315; the telephone number to district 2 train dispatcher is 265-2316.**

**Southward trains at Palmer Junction use channel 2 to call-in to the district 1 train dispatcher and northward trains at Palmer Junction use channel 8 to call-in to the district 2 train dispatcher.**

**Southward trains at Willow use call-in code 05 to contact the district 1 train dispatcher and northward trains at Willow use call-in code 06 to contact the district 2 train dispatcher.**

**Report problems with these, or any other, radios by calling the communication trouble-line message recorder at extension 2370. Give specific and detailed information about the communication problem when leaving a message.**

## 83.26 RADIO TELEPHONE OPERATION

For dial tone, enter [ \* 1 ], then dial number.

To disconnect, enter [ # ]; **MUST** be used when through conversing.

To call a radio telephone on the same base station as you are, enter [ \* 1 ], wait for beep, then dial “00”.

### RADIO TELEPHONE BASE STATION NUMBERS

Seward	Channel 11	2627
Moose Pass	Channel 09	2627
Portage	Channel 10	2667
Campbell Point	Channel 09	2668
Site Summit	Channel 11	2629
Wasilla/Palmer	Channel 10	2335
Talkeetna	Channel 10	2331
Hurricane	Channel 09	2633
Cantwell	Channel 11	2637
Healy	Channel 10	2332
Nenana	Channel 09	2654
Fairbanks	Channel 11	2333

To make an emergency call from a radio telephone to FIRE/POLICE/MEDICAL, enter [ \* 1 ], wait for dial tone, enter [ 9 ] for commercial dial tone, then enter [ 9 1 1 ]. It may take up to ten seconds for the operator to answer — do not hang up. **This rings into the Anchorage 911 office, they can connect you with the service you need.**

Dial [ \* 1 ], wait for dial tone, then dial the three-digit code shown below first to access the following area telephone exchanges toll free:

Seward/Moose Pass .....	821, then local number
Whittier .....	826, then local number
Anchorage .....	9, then local number
Mat-Su Valley .....	824, then local number
Healy/Denali Park .....	822, then local number
Fairbanks .....	823, then 9, then local number

Radio-telephone base station radios time-out after 12 minutes of continuous use. Enter [ \* ] within this time period, or after hearing a short beep, to reset the timer.

### 83.27 RADIO BASE AND WAYSIDE STATION LOCATIONS, TIMES ATTENDED AND ASSIGNED CHANNELS

Base		Hours in
<u>Station</u>	<u>Channel</u>	<u>Service and Attended</u>
Seward	1,5&6	24 hours unattended
Whittier	1,5&6	24 hours unattended, except during barge-switching operations
Anchorage Yard	3,4,5* & 6	Generally attended between 0700 and 2300 *Press 00 while on channel 5 as alternate way to contact the terminal.
Usibelli Tipple	4	24 hours unattended except during coal-loading operation
Fairbanks	3&4	Generally attended 24 hours

### 83.28 MAINTENANCE OF WAY RADIOS

To call Engineering office, use call-in code 19.

To call dispatcher, use call-in code 20.

<u>Base Radio</u>	<u>Channel</u>	<u>Base Radio</u>	<u>Channel</u>
Seward	12	Talkeetna	15
Moose Pass	14	Gold Creek	12
Portage	15	Hurricane	13
Whittier	12	Cantwell	14
Campbell Point	14	Denali Park	12
Anchorage	15	Garner	15
Willow	12	North Nenana	13
		Ester Dome	12

## 83.29 GAME ANIMALS/LIVESTOCK

When trains hit any large animal, train will come to a complete stop and train inspection will be made, except when it is known animal is clear of track and will cause no danger to movement of trains.

Whenever any animal is struck or killed by trains, a report must be made to the Train Dispatcher immediately.

## 83.30 FIXED SIGNALS

The following fixed signals will indicate information as shown.

### 83.30.1 Advance Yard Limit Sign

Indicates yard limit territory 1 measured mile ahead.

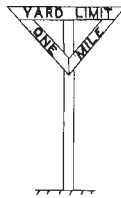

### 83.30.2 Yard Limit Sign

Indicates beginning of yard limits. When displayed on left-hand side of track, it indicates leaving yard limits.

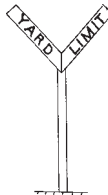

### 83.30.3 Flanger Sign

Indicates 100 feet beyond is a guard rail, road crossing, switch, frog, etc., that will not clear flangers and snow plows.



### 83.30.4 Measured Mile Signs

Placed 1 mile apart at designated locations along main track to check accuracy of speed indicator.



### 83.30.5 Advance Warning Speed Control Sign

Placed ½ mile in advance of a permanent speed restriction. Train or engine must be so controlled as to not exceed speed specified ½ mile beyond. **Black numbers on yellow sign.**

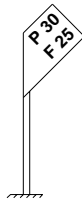

### 83.30.6 Speed Control Sign

Indicates beginning of a permanent speed restriction. Train or engine must not exceed speed specified once front of train or engine has passed this sign. **Black numbers on yellow sign.**

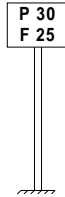

### 83.30.7 Resume Speed Sign

Indicates end of a permanent speed restriction. Speed must not be increased until entire train has passed this green signal. **Yellow numbers on green sign.**

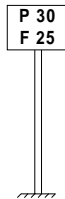

*Be safe, stay alert,  
chances are you  
won't get hurt.*

### 83.30.8 Speed Control Sign

Indicates the end of the speed restriction shown on the preceding speed control sign and the beginning of the speed restriction as shown. Speed of train or engine must not be increased to the speed shown on this sign until last car of train or engine has passed this sign. **Yellow sign with black numbers if adjacent speed restriction is less than first one. Green sign with yellow numbers if adjacent speed is greater than the first restriction.**

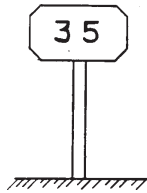

### 83.30.9 Advance Warning Slide Zone Sign

Placed ½ mile in advance of slide zone.

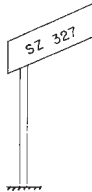

### 83.30.10 Slide Zone Sign - Front

Indicates beginning of a slide zone. Speed of train must be controlled as per Timetable Special Instructions.



### 83.30.11 Slide Zone Sign - Back

Displayed on left-hand side of track to indicate end of slide zone.



### 83.30.12 Station Warning Sign

Placed 1 mile in advance of first switch of a station or 1 mile in advance of station sign if no siding. Sound one long engine whistle signal while passing this signal.



### 83.30.13 Road Crossing Warning Sign

Placed ¼ mile in advance of road crossings. Sound engine whistle as directed by Rule 5.8.2(11). Sound engine bell as directed by Rule 5.8.1.





### 83.30.14 Bridge and Tunnel Warning Sign

Placed approximately  $\frac{1}{4}$  mile in advance of bridges and tunnels. Sound engine whistle as directed by Rule 5.8.2(11).



### 83.30.15 Mile Post Sign

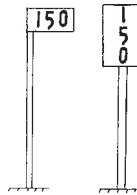

### 83.30.16 Bridge Sign



### 83.30.17 Tunnel Approach Sign



### 83.30.18 Station Sign

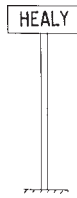

### 83.30.19 Derail Sign for Switch Stand

Attached to derail. When sign is facing movement, derail is in derailing position and must be changed to the off position to permit movement.



### 83.30.20 Derail Post

Displayed where short stand derail is located.

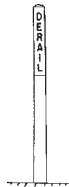

### 83.30.21 Advance Restricted Clearance Sign

Placed in advance of condition which will not clear employee on top or side of a car.

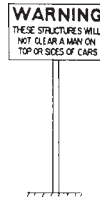

### 83.30.22 Restricted Clearance Sign

Placed at the point where clearance is restricted.



### 83.30.23 End of Track Sign

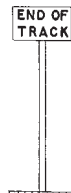

### 83.30.24 End Block Sign

Indicates the end of a signal block.

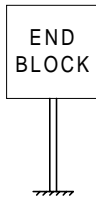

### 83.30.25 Begin Block Sign

Indicates the beginning of a signal block.

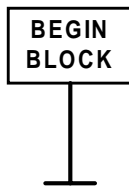

### 83.30.26 Temporary Speed Restriction Sign (yellow signal with green numbers) used on Auxiliary Tracks and Main Tracks within Yard Limits

A yellow signal with green numbers displayed on the right-hand side of the track as viewed from an approaching train or engine indicates the beginning of a temporary speed restriction. Do not exceed speed specified until rear car has passed the backside of this same signal displayed on the left-hand side of the track. **This sign is an exception to GCOR.**

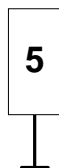

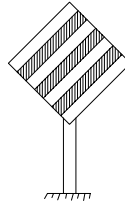
**83.30.27 Malfunctioning Automatic Crossing Warning Signal Sign (white signal with red stripes)**

When viewed at a signalized crossing on the right side of the track, as viewed from an approaching engine, this signal indicates the automatic crossing warning signals may not operate properly. Movement over the crossing must be protected as prescribed by Special Instructions whenever this signal is displayed. When this signal is displayed on the left side of the track, as viewed from an approaching engine, it indicates the end of the restriction. Any crossings between these signals must be protected as prescribed by Special Instructions. This signal will only be displayed where Rules 6.27 and 6.28 apply.

**83.30.28 Begin CTC Sign**

Indicates the beginning of centralized traffic control.



**83.30.29 End CTC Sign**

Indicates the end of centralized traffic control.

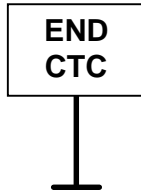

**83.31 DETERMINING NUMBER OF HAND BRAKES TO APPLY**

Refer to specific operating instructions/procedures for the proper number of hand brakes to be applied. If not provided, use the following table to determine the minimum number of hand brakes to apply or wheels to block to hold equipment on a grade.

Row	Grade	Number of Cars on Which to Fully Apply Handbrakes
A	Level	1 for every 50
B	0.1% - 1.0%	1 for every 6
C	1.1% - 2.0%	1 for every 4
D	Greater than 2.0%	1 for every 2

**83.32 SIGNAL ASPECTS AND INDICATIONS, GCOR RULE 9.1**

Distant, block, and interlocking signal aspects are shown at the back of this timetable.

## 84.0 GENERAL CODE OF OPERATING RULES

All rules in the General Code of Operating Rules (GCOR [forth edition, effective April 2, 2000]) are in effect on the Alaska Railroad (ARRC) with the issuance of this Timetable, except as follows:

- GCOR Rule 1.5 add and change the following:
  - Measurable alcohol is defined to be .02 percent or greater breath alcohol content.
  - The use or possession of alcoholic beverages while on duty is prohibited. Employees must not have any measurable alcohol in their breath or in their bodily fluids when reporting for duty or while on duty. The use or possession of intoxicants, over-the-counter or prescription drugs, narcotics, controlled substances, or medication that may adversely affect safe performance is prohibited while on duty, except medication that is permitted by a medical practitioner and used as prescribed. Employees must not have any prohibited substances in their bodily fluids when reporting for or while on duty.
- GCOR Rule 1.11.1 does not apply on ARRC.
- GCOR Rule 1.41 does not apply on ARRC.
- GCOR Rule 5.4.5, second bullet, changed to read:
  - Place a green flag at the end of each speed restriction.

Diagram A is changed to show:

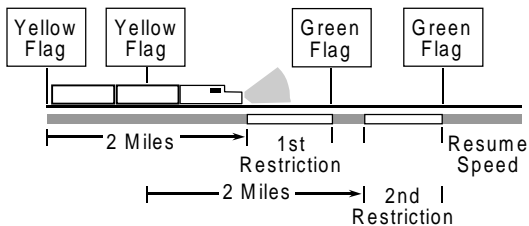

- GCOR Rule 5.4.8, delete first paragraph and reissue as follows:
  - Flags will be displayed on the track affected. Flags must also be placed to protect all possible access to the restricted area.

- GCOR rule 5.8.1, add and change the following:
  - While passing passenger stations.
  - While switching in buildings and shop areas.
- GCOR Rule 5.8.2 add the following:
  - When other employees are working in the immediate area, sound the required whistle signal before moving. Whenever roadway workers are seen to be on or near the tracks, sound the required whistle signal. Roadway workers can be identified by **an orange hard hat** or a reflective yellow strip on the front, back, and sides of their hard hat. Whistle signals should be sounded as shown on the following chart. The radio may be used in place of whistle signals, except signals 1 and 11.
- GCOR Rule 5.11 is changed to read as follows:
  - Trains will be identified by engine number, adding the direction when required. When an engine of another company is used, the initials of the company will precede the engine number. When an engine consists of more than one unit or when two or more engines are coupled, the number of one unit only will be illuminated as the identifying number. When practical, use the number of the leading unit.
- GCOR Rule 6.8, change the following:
  - A train entering a siding that may be met or passed must stop at least 400 feet from the signal or clearance point of the facing point switch the other train will pass over, if length of train permits.
- GCOR Rule 6.10, is changed to read as follows:
  - All crew members must remind the engineer that the train is approaching an area restricted by:
    - Limits of authority  
At known meeting points, immediately after passing the last station prior to the meeting point, all crew members must remind the conductor or engineer to call the opposing train to verify the requirements of the trains at the meeting point. If the identifying engine number of the opposing train is not known, the conductor or engineer will refer to them as “the train authorized to \_\_\_\_\_”.
    - Track warrant  
or
    - Track bulletin



All crew members must inform the engineer after the train passes the last station, but at least 2 miles from the restriction. If the engineer fails to comply with the restriction, the conductor or other crew member must stop the train.

- GCOR Rule 6.11, Spacing Trains, does not apply on ARRC.
- **CCOR Rule 6.23, Emergency Stop or Severe slack Action, add the following:**
  - **When a train or engine is stopped by an undesired emergency application of the brakes or severe slack action occurs while stopping, the train crew must consider the following when determining whether an inspection of the train is necessary:**
    - severity of slack action
    - commodities being handled in train
    - whether it is a recurring undesired emergency brake application or an isolated incident.

**If the above factors have been considered and it is the crew's determination that an inspection is unnecessary, train may proceed without inspection.**

- GCOR Rule 6.32.1, is reissued as follows:
  - When cars are shoved over road crossings at grade, a crew member must be on the ground at the crossing to warn traffic until the crossing is occupied. Make any movement over the crossing only on the crew member's signal. This procedure is not required when:
    - at signalized crossings, the signals are working and, if so equipped, the gates are in the fully lowered position; or
    - the movement is controlled by a crew member on the leading car, or,
    - it is clearly seen that no traffic is approaching the crossing.

- **GCOR Rule 6.32.2, Automatic Crossing Devices, is changed as follows:**
  - Under any of the following conditions, a movement must not foul a crossing equipped with automatic warning devices until the device has been operating long enough to provide warning and the crossing gates, if equipped, are fully lowered.
    - Movement has stopped within 3,000 feet of the crossing.
    - Movement is within 3,000 of the crossing and speed has increased by more than 5 MPH.
    - Movement is closely following another movement.
    - Movement is on other than a main track or siding.
  - or*
  - Movement enters a main track or siding within 3,000 feet of the crossing.
- A. Automatic Warning Devices Malfunctioning**  
Use the following table to properly complete movement over the crossing:

<b>Movement When Automatic Warning Devices Are Malfunctioning</b>	
<b>If ...</b>	<b>Then ...</b>
Someone is not at the crossing to provide warning.	Stop before occupying the crossing. After a crew member is on the ground at the crossing to warn highway traffic, proceed over the crossing on hand signals from that crew member, or <b>If devices are seen to be working, or when <i>instructed</i> by the train dispatcher, proceed over the crossing at 15 MPH without stopping until the head end of the train completely occupies the crossing. Then proceed at normal speed.</b>
The crew is notified that the crossing has one equipped flagger who is unable to provide warning in all directions of approaching traffic.	Proceed over the crossing at 15 MPH without stopping until the head end of the train completely occupies the crossing. Then proceed at normal speed.
The crew is notified that the crossing has one or more equipped flaggers who are able to provide warning in all directions of approaching traffic.	Proceed over the crossing at normal speed without stopping.
NOTE: An <u>equipped flagger</u> is a person other than a crew member who is equipped with an orange vest, orange shirt or orange jacket. At night, the vest, shirt or jacket must be fluorescent. The flagger must have a red flag or stop paddle by day and a light at night.	
When advised by the train dispatcher that the malfunctioning automatic warning devices have been repaired these restrictions no longer apply.	

- GCOR Rule 7.6, add the following:
  - Apply a sufficient number of handbrakes, except each locomotive left unattended must have its handbrake applied, to prevent movement.
- GCOR Rule 7.12, change the following:
  - Stop the movement before the end of track.
- GCOR Rule 8.2, change the following:
  - The employee must not allow movement to foul a main track switch until the hand-operated switch or derail is properly lined.
- GCOR Chapter 11 does not apply on ARRC.
- GCOR Chapter 12 does not apply on ARRC.
- GCOR Chapter 13 does not apply on ARRC.
- **GCOR Rule 14.4, Occupying Same Track Warrant Limits, Item 5 is added as follows:**

### **5. Radio Blocking**

**In non-signaled territory, more than one train may be authorized within the same or overlapping limits, provided that the following train:**

- **Is notified on the track warrant of the identity of the preceding train.**
- **Does not foul the limits ahead of the preceding train.**
- **Is notified by the preceding train that the entire train has passed a specific location. Location specified must not be beyond limits indicated. The following words must be used: “(Train) has passed (location).”**
- **Does not proceed beyond the last location the preceding train has reported to have passed.**

**All instructions between the trains must be written, repeated and acknowledged with “That is correct” before being acted on. These written instructions (in format show below) between the trains must be retained until the end of tour of duty.**

**Written Instructions Between Trains:**

**(Preceding Train ID) has passed (Specific Location) at (Time)**

**When all available lines on track warrant form have been filled in, new track warrant authority must be obtained. Notify the train dispatcher if communication cannot be established between the two trains. If necessary, radio**

**blocking information may be relayed only by the train dispatcher.**

**The last named point of the following train’s authority must not extend beyond the authority of the preceding train.**

**The conductor must remind the engineer that they are approaching the location last reported passed by the preceding train not less than two miles from that location. If the engineer fails to acknowledge this information, the conductor must take further action to stop the train.**

**In the application of Rule 6.4 (Reverse Movements) and Rule 6.6 (Picking Up Crew Member), the movement must not go beyond the last specific location reported to the following train.**

- GCOR Rule 14.11, the following line is canceled:
  - When a track warrant of a previous date is voided, the date must be included.
- GCOR Rule 14.13, add the following:
  - A mechanically transmitted track warrant **MUST NOT BE ACTED UPON** until comparison of the track warrant has been made with the train dispatcher.
- **GCOR Rule 14.14, Employee Reporting Clear of Track Warrant Limits is added as follows:**  
**An employee reporting clear of track warrant limits must inform the dispatcher:**
  - **Name of employee reporting clear of limits.**
  - **Equipment identification (locomotive or vehicle number).**
  - **Track warrant number.**
  - **The last named point of a directional track warrant or both specific points of a “WORK BETWEEN” track warrant.**
  - **Time the limits were cleared.****The train dispatcher will repeat the information before clearing the limits of the track warrant.**
- GCOR Rule 15.1, add the following:
  - The following Track Bulletin Forms are authorized for use:
    - Form C: high, wide or restricted car notification.
    - Form F: free-form text.
    - Form S: Slide Zone activation.
- GCOR Chapter 16 does not apply on ARRC.

## GCOR Changes and Exceptions

---

- GCOR Chapter 17 does not apply on ARRC.
- GCOR Glossary, add the following abbreviation:
  - TB - Track Bulletin
- GCOR Glossary, add the following definitions:
  - AUXILIARY TRACK - Any track other than a main track.
  - **CS - Controlled Signal.**
  - QUALIFIED EMPLOYEE - An employee instructed and examined on the rules applicable to their duties.

*Common sense has  
determined that  
carelessness is  
hazardous to your  
health.*

*A safe attitude is the  
best insurance  
against accidents.*

## **85.0 ALASKA RAILROAD SAFETY MANUAL**

### **22.5 DARK LENS EYE PROTECTION**

Do not wear dark lens glasses or goggles at night (sunset to sunrise) when insufficient lighting conditions exist, or when working indoors, unless you are welding or using a torch. Employees operating equipment making abrupt transitions from light to dark must not wear photogray or transition lenses.

### **29.2.1 GETTING ON AND OFF MOVING EQUIPMENT**

Employees qualified in train and engine service may get on and off moving rail equipment under the following conditions:

- 1. In ARRC terminals, when authorized by terminal superintendent bulletin or general order.**
- 2. In industries served by ARRC, when such tracks and walkways have been inspected by the appropriate supervisor and approved through terminal superintendent bulletin or general order.**
- 3. At other locations that may be designated by general order.**

Speed at the time of the mount/dismount in approved locations must not exceed walking speed.

### **31.2.1 GOING BETWEEN CARS COUPLED TO LOCOMOTIVES OR BETWEEN LOCOMOTIVES COUPLED TO LOCOMOTIVES**

Before going between, or working on the end of cars or locomotives:

- Make sure that crew members have a clear understanding of the work to be performed.

## Safety Manual Rule Changes

---

- Unless positive protection is provided, all crew members must ensure proper safeguards, as listed below, are in place:
  - When a crew member is required to go between or work on the end of equipment, they must notify the engineer and all other crew members who could affect movement of the equipment, by radio or hand signal.
  - The engineer, and all other crew members who could affect movement of the equipment, must verify by radio, hand signal or whistle signal (1 long) that they understand a crew member will be going between or working on the end of equipment.
  - When hand or lantern are used, the following signal will be used both to notify and to verify that a crew member is going in between or working on the end of equipment:
    - Day signal: Start with arms at side of body swinging them out, up and in, with hands meeting in center of body about waist height. Engineer must acknowledge with same hand signal or whistle signal 5.8.2 (2).
    - Night signal: Movement of lantern about chest high from side to side parallel to the ground. Engineer must acknowledge with same hand signal or whistle signal 5.8.2 (2).
  - When radio is used employee will announce “going between”. The engineer will respond by radio only “set and centered”. A combination of hand and radio signals is prohibited.
  - When the engine is coupled to the equipment which is not to be moved, the engineer must:
    - center the reverser,
    - fully apply the independent brakes, and automatic brakes, when required before acknowledgment is made.
  - The engineer, and all other crew members, must ensure the equipment being secured will not move until the crew member who requested protection has reported by radio or hand signal the he is no longer between, or on the end of, the equipment.
  - The crew member going between or working on the end of equipment must wait until all movement of equipment has stopped and the slack has adjusted. If handbrakes are being released, take proper safeguards to ensure slack has adjusted.
  - Crew members going between or working on the end of equipment which may be coupled into or moved by other crews at that location must first communicate with the employee in charge of terminal movements to ensure equipment being secured will not be coupled into or moved. Employee in



charge of crews must not authorize movement into the affected track until notified that the crew member being protected has completed the work and is in the clear of secured equipment.

- When stepping out from between cars or locomotives, employees must watch for equipment moving on adjacent tracks or vehicles and machinery moving on the tow path, walkway, or roadway.
- Do not go between uncoupled locomotives or cars when clearance between them is less than 50 feet, unless these safeguards are provided. When applicable, blue signal protection must be provided.

### 43.2.6 FLAG LOCATION

- Delete first paragraph and reissue as follows:  
Flags will be displayed on the track affected. Flags must also be placed to protect all possible access to the restricted area.

## 43.7 REQUESTING AND USING TRACK BULLETIN FORM B

Change to 43.7.1, Number 1:

- **When possible, request the Form B from the designated employee by 16:00 hours the day before the effective date. All Saturday, Sunday and Monday Form B's should be requested by 16:00 hours on the Friday preceding the weekend, or the day before a holiday.**

Add Rule 43.7.3 as follows:

- Track car operators must stop at the indicated limits even if no red flag is displayed.
- Track car operators must be informed of Form B limits. The train dispatcher can provide Form B territory information using any of the following methods:
  - If the track car operator can obtain a Form B Track Bulletin for that subdivision, the bulletin may be compared with the train dispatcher.  
or
  - The train dispatcher may issue the track car operator a track bulletin containing all necessary Form B information.  
or

- The train dispatcher may indicate the limits of a Form B in the other specific instructions of the track warrant.  
or
- The train dispatcher may issue track warrant authority that ends at the working limit of the Form B territory. A track car operator receiving this type of authority would go to the end of the track warrant limits, then request permission from the EIC to share the Form B limits.

Note: whenever Form B information is received by either method 1 or method 2, it remains in effect for the tour of duty, unless voided by the train dispatcher.

### 44.3 WEARING SEAT BELTS

#### Exception:

- **Seat belt use is not required if vehicle is used during the task of inspecting cars, performing air brake test, coupling air hoses or changing brake shoes, and speed of vehicle does not exceed 5 mph. Seat belt must be worn to and from train or track.**

### 44.7 BACKING UP

Position the vehicle, when possible, to avoid back-up movement. If it is safe to do so, before backing, get out of vehicle and inspect areas to the rear to make sure no person or obstruction is in the path of movement. When available, position someone to the rear to guide movement to completion on all reverse moves. Stop immediately if the person guiding the movement disappears from view. Sound the horn three short blasts for vehicles not equipped with a backup alarm before making a back-up move with a company vehicle or on company property.

### 58.4.2 NON-CONTROLLED TRACK

**Addition to 58.4.2, Non-Controlled Track, The roadway worker establishes working limits on non-controlled track by any of the following methods, add new fifth bullet:**

- **Where remote controlled switches provide direct access, the employee in charge of the workmen must tell the train dispatcher what work will be done. The train dispatcher must then:**
  - **Inform the employee in charge of the workmen that the switches have been lined against movement onto the track and devices controlling the switches have been secured.**
  - **Not remove the locking devices, nor give permission to operate the dual control switches by hand, unless the employee in charge of the workmen says it is safe to do so.**
  - **Maintain for 15 days a written record of each notification that includes:**
    - **Name and craft of the employee in charge of the workmen requesting protection.**
    - **Identification of track involved.**
    - **Date and time the employee in charge of workmen is notified that protection was provided.**
    - **Date, time, name and craft of the employee in charge of workmen who authorized removal of the protection.**

## **58.6 AUDIBLE WARNING FROM TRAINS**

**Audible Warning from trains, is changed to read as follows:**

**Trains must provide continuous audible warning to roadway workers when both approaching and passing through a work group. The warning must be a combination of a series of short sounds of the the whistle, and the continuous ringing of the locomotive bell, until the lead locomotive is completely past the workers.**

**To give trains advance notice of roadway workers on or near the track, each roadway worker fouling the track must wear at least one of the following items:**

- **Orange reflective strips on a hard hat.**
- **Orange hard hat.**
- **Orange reflective vest.**

*Safety is a state of  
mind,  
accidents are an  
absence of mind.*

*Be generous to  
others, share a  
safety tip!*

*A positive attitude  
creates positive  
results.*

## **86.0 AIR BRAKE AND TRAIN HANDLING RULES**

### **86.1 AIR BRAKE AND TRAIN HANDLING MANUAL RULE CHANGES**

- **Rule 61.3.5, Performing an Initial Terminal Air Brake Test on a Train not Kept Charged, as follows:**
  - **NOTE: A train considered “kept charged” has had its brake system charged to at least 60 psi within the last 4 hours.**
- **Rule 61.6 Air Brake Test When Cutting Off and Recoupling, change the first and last paragraphs from 2 hours to 4 hours.**
- **Rule 63.2, Inspecting Freight Cars:**
  - **When a brake shoe defect is discovered:**
    - **If the entire brake shoe is missing, cut the air out of the car and handle car to nearest repair facility.**
    - **If only part of the brake shoe is missing, it is not required to cut out the air. Handle the car to the nearest repair facility to be repaired.**
  - Notify the train dispatcher what action was taken, if any.**
- **Rule 63.6.8 Bleeding Off Cars (delete fourth bullet)**
  - **Bleed off cars only in the following situations:**
    - **When repairing the brake system.**
    - **When cutting out the brakes on a defective car.**
    - **When switching.**
- **Rule 63.10.1 Applying Hand Brakes on Cars, as follows:**
  - **Sections 3, 4, and 5, of this rule are cancelled.**
  - **When securing cars or a portion of a train, apply enough hand brakes to prevent movement.**
    1. **When determining the number of hand brakes to be fully applied or the blocking needed to hold cars without airbrakes, consider the following factors:**
      - **Grade and adhesion.**
      - **Loaded or empty equipment.**
      - **Weather, wind and temperature.**
    2. **When applying hand brakes:**
      - a. **Use proper body mechanics to prevent injury.**
      - b. **Do not use a device for additional leverage, such as a bar, brake club, or your foot.**

- c. Fully apply hand brakes by operating the mechanism until the slack is out of the chain and the brake shoes are snug against the wheels.

- **Rule 63.10.3 Securing a Train or Portion of Train Without Locomotive Attached, is changed to read as follows:**
  - **When securing a train or portion of a train without a locomotive attached in territory at or less than 1% grade:**
    1. **Make a 20 PSI brake pipe reduction.**
    2. **Close the angle cock on the locomotive(s) or equipment that will remain with the locomotive(s).**
    3. **Cut away and allow the train or portion of the left standing to apply in emergency. Leave the angle cock on the equipment left standing in the fully open or fully closed position as required.**
    4. **Immediately apply a sufficient number of hand brakes on the equipment left standing as prescribed by Rule 63.10.1.**

---

**CAUTION:** Do not bottle the air or maintain air pressure in the brake pipe unless locomotives are attached.

---

- **Rule 63.10.4 Securing a train or Portion of Train Without Locomotive Attached, in territory greater than 1% grade, addition:**
  1. **Make a 20 PSI brake pipe reduction.**
  2. **Apply a sufficient number of hand brakes on the equipment left standing as prescribed by Rule 63.10.1.**
  3. **Close the angle cock on the locomotive(s) or equipment that will remain with the locomotive(s).**
  4. **After cutting away, leave the angle cock on the equipment left standing in the fully open or fully closed position as required.**

---

**CAUTION:** Do not bottle the air or maintain air pressure in the brake pipe unless locomotives are attached.

---

- **Rule 64.12.1 Operating on a Grade, additions:**
  8. **No train will operate at less than 5 mph while ascending a grade. Prior to train speed decreasing below 5 mph the engineer must prepare for a stop by immediately making a minimum brake pipe reduction, and must continue making additional reductions until train has stopped. Regardless of**

the type of locomotive being operated (e.g. GPs or SD70MACs) if the train begins moving backwards as throttle is reduced, the engineer must immediately place the reverser in the direction of roll-back and apply the dynamic brakes to control speed. Brake cylinder pressure must be kept below 15 psi for maximum dynamic braking. If the speed of the train cannot be controlled, the engineer must immediately place the train in emergency.

- If operating SD70MACs and the train is placed in emergency, dynamic braking is reduced to a setup level. To achieve maximum dynamic braking, place the reverser handle in the opposite direction of roll-back. This will activate “Opposite Directional Braking”, a feature found exclusively on the SD70MAC locomotives. Brake cylinder pressure must be kept below 15 psi for maximum dynamic braking.
- If operating GP locomotives, full dynamic braking remains available after an emergency application. Brake cylinder pressure must be kept below 15 psi for maximum dynamic braking.

Do not attempt to reset the PCS until the train has come to a complete stop. After the train has stopped properly secure the train, per Timetable Special Instructions Item No. 83.35, Determining Number of Hand Brakes. Once train is secured move the automatic brake valve to the RELEASE position to recharge the train. Conductor must confirm with the engineer the maximum tonnage that can safely be handled over crest of grade before releasing hand brakes and proceeding.

## 86.2 LOCOMOTIVE SPECIAL HANDLING

Locomotive engineers must ensure the maximum number of operating locomotive axles in their consist, in power or dynamic braking, do not exceed 24. Helper service locomotives count as a separate consist. When calculating for consists that include six axle SD70MAC locomotives, count these units as having eight axles.

Locomotives handled dead-in-tow will be placed immediately behind the road engines, except rail diesel cars which can only be handled as the last car in a train.

## Air Brakes and Train Handling Rule Changes

---

Locomotives, when coupled to another car or locomotive, must not be coupled with more force than is necessary to make the coupling.

MP 15 Locomotives Nos. 1551, 1552, 1553, and 1554

- These locomotives must not be moved in trains handling loaded tank cars (this does not include yard engines).
- When handled in trains, these locomotives must have coupler stops in place that restrict the coupler swing.
- Not more than one of these locomotives can be moved in a train.
- Authorization from the Superintendent of Transportation and the Chief Mechanical Officer (or their designees) must be obtained before any of these locomotives are moved in a train.

Hostler movements are to be protected with a groundworker at all times. Hostlers are not authorized to make individual movements of locomotive power or equipment without another employee physically directing the movement.

If operating conditions allow, locomotive sanders are not to be manually activated passing over way-side track lubricators.

Whenever a locomotive is to be left unattended the doors are to be secured or locked, if possible, and **handbrake tied**.

SD70MAC locomotives can operate light engine on any track except: Hunter and Chulitna wye tracks. Restrictions shown in the Special Instructions are for SD70MAC locomotives handling cars. To determine whether a track, not listed in Special Instructions, is suitable for SD70MAC operation: measure the rail from the base of the rail to the top of the rail; do not operate on rail measuring less than six inches. Any track listed as out of service may be authorized for use by an engineering supervisor.

If necessary to work beneath a SD70MAC locomotive, use the following procedures:

- After the locomotive has been brought to a stop, center the reverser and leave the Isolation Switch in RUN.
- Use the display screen to activate the DC Link Shorting Test (on the second page of the Self-test Menu).



- During the test, the screen will prompt the engineer to isolate the unit. Once the test is completed, leave the Isolation Switch in Isolate.
- At this point, the engineer knows the DC Link has been discharged. As long as the Isolation Switch remains in Isolate, the DC Link will not be recharged and it is therefore safe to work beneath the locomotive without shutting down the diesel engine.

Switching passenger equipment, the following will apply:

- “When coupled to a GP locomotive, SD70MAC locomotives will be isolated while switching passenger equipment.”
- “A trainman must be positioned on the leading car of the shoving movement and must be in control of the emergency valve.”
- “Movement must be controlled so that speed does not exceed 3 MPH beginning three car lengths before the safety stop.
- “The engineer must set a minimum reduction at least five car lengths prior to the safety stop.” 86.3 Locomotive Head End Power Operating Instructions
- If necessary to switch passenger equipment or outfit cars that have ineffective or inoperative air brakes, do not handle more than two cars at one time. Do not allow passengers or employees, other than train crew members, to ride on passenger equipment or outfit cars with inoperative or ineffective air brakes while being switched.

Use the following procedure to discharge the DC link to remove a moose from beneath a SD70MAC locomotive:

- After the locomotive has been brought to a stop, center the reverser and leave the Isolation Switch in RUN.
- Use the display screen to activate the DC Link Shorting Test (on the second page of the Self-test Menu).
- During the test, the screen will prompt the engineer to isolate the unit. When the test is completed, leave the Isolation Switch in Isolate.
- At this point, the engineer knows the DC Link has been discharged. As long as the Isolation Switch remains in

Isolate, the DC Link will not be recharged and it is therefore safe to remove the moose without shutting down the diesel engine.

### **86.3 LOCOMOTIVE HEAD END POWER OPERATING INSTRUCTIONS**

Instructions below apply to locomotives 3009, 3010, 3011, **3013, and 3014:**

#### START-UP:

1. Check fluid levels.
2. Open the upper right hand electric cabinet door and turn on the circuit breakers located at the bottom portion of the door.
3. Place the isolation switch to the 240 volt position for KFF service or 480 volt position for passenger service.
4. Verify that the green “Train Line Complete” indicator lamp is illuminated.

Note: In 480 volt (passenger) service, if the green “Train Line Complete” indicator is not illuminated, ensure all the cables and connections are properly connected and the last coach is looped back into itself.

5. Turn the start switch to the start position until the engine starts. Release the switch and it will return to the run position.
6. Let the engine warm up for approximately two to three minutes. Push the reset button. Using the speed control switch, increase the RPMs by pushing up and holding the switch until the cycle gauge shows 60 cycles.

Note: If after increasing the RPMs some and the cycle gauge does not show an amount of cycles, push the reset button again.

7. At this time (cycle gauge reads 60), the voltage gauge will read 240 volts for KFF service or 480 volts for passenger service plus or minus a maximum of 5 volts.
8. Push the HEP ON button.

9. Verify voltage and cycles are still correct. Adjust if necessary by increasing or decreasing RPMs using the speed control switch.

**Note 1:** You cannot adjust the voltage setting. It will increase or decrease in direct relation to the cycles, but if the cycles are set on 60 and you only show, for example, 440 volts in the passenger position, there is a problem. This is the same for the 240 volt service.

**Note 2:** The amperage gauge also cannot be adjusted. This gauge will fluctuate as the load demands from the equipment change.

### SHUTDOWN:

1. Push the HEP OFF button. The amperage gauge will drop to “0”.
2. Using the speed control switch, decrease the engine RPMs by pushing and holding down on the switch until the cycle gauge shows approximately 45 to 50 cycles.
3. Turn the engine start switch from the RUN position to the OFF position.
4. Turn isolation switch to isolate.
5. Turn off the circuit breakers located on the inside of the upper right front cabinet door.

Instructions below apply to locomotives 3013, 3014, and 3015:

### TRAINLINESETUP:

When running from long hood end, both rear plugs must be jumpered. When running from short hood end all three corners must be jumpered.

### START-UP:

1. All breakers mounted inside the upper right electrical cabinet should be in the CLOSED position.
2. Select long or short hood trainline set up.
3. Put isolation switch in RUN position.
4. The idle switch and HEP switch should be in NORMAL position.

## Air Brakes and Train Handling Rule Changes

---

5. After the above procedures the HEP ready light and both green train line complete arrow lights should be on.

### START-UP (IF STANDBY MODE IS USED):

1. All breakers mounted inside the upper right electrical cabinet should be in the CLOSED position.
2. Put the isolation switch in the START/STOP position.
3. Put isolation switch in LOW position.
4. Press START.

### TROUBLESHOOTING

- In passenger service, if power is lost to the train, first verify the engine is not in an overheat condition by looking at the temperature gauge. An overheat condition is a reading on the gauge of above 200 degrees. The engine can still be running in this situation due to the first stage of correction is to nullify power to the train. If it continues to overheat, the engine will eventually shut down. When shutdown occurs, the control circuits will not allow the engine starter to be engaged until the temperature decreases to approximately 180 to 190 degrees.
- Allow the engine to cool, verify the “Train Line Complete” light is on. If the engine is running, push the reset button, verify the voltage and cycles are correct, push the HEP ON button. Verify the voltage and cycles are correct once more. Adjust if necessary using the speed control switch. The AMP gauge should show amperage.
- If the engine is not in an overheat condition and the green “Train Line Complete” light is on and no other fault lights are on, push the reset button, verify the voltage and cycles are correct, push the HEP ON button. Verify once more the voltage and cycles are correct. Adjust if necessary.
- If the engine is not running, verify it is not in an overheat condition. If it is, allow the engine to cool to 180 to 190 degrees, check the fluid levels and that the circuit breakers are in proper position. Verify the green “Train Line Complete” light is on. Turn the engine start switch to the OFF position to reset the starting circuit and restart the engine. Press the reset button and verify again there are no fault lights on. Check voltage and cycle gauges, push HEP

ON button. Verify voltage and cycles are correct. Adjust if necessary.

- If green train line complete light is not on, verify cables and connections are intact. When the missing link is found, correct it and verify the green “Train Line Complete” light is on. Push reset button, then push the HEP ON button.

Note: The HEP OFF and HEP ON buttons do not shut the engine on or off. They energize or de-energize the train. If doing anything to the connections, push the HEP OFF button. If the train line complete light is not on, you do not have to be concerned with the train line being energized. It will automatically de-energize the train. You can confirm there is no electricity to the train by verifying the reading on the amperage gauge is “0”.

### **86.4 CABOOSE SPECIAL HANDLING**

Unless otherwise authorized, cabooses, including unoccupied cabooses, must be handled only as the rear car of the train. This requirement does not apply to trains consisting of less than 20 cars and not exceeding 2500 tons.

Whenever a caboose is to be left unattended, the doors are to be secured or locked, if possible.

Conductors must not delegate the responsibility of riding the caboose of their train to another crew member, unless the crew member has at least six months of cumulative train service experience.

### **86.5 BAGGAGE CAR GENERATORS**

**Baggage Cars #100, 101, 110 and 111:**

**SETUPFORBAGGAGECARGENERATORS:**

1. Four hundred-eighty volt cables must be jumpered on all corners of the baggage car that are not being used.
2. Settings for switches in the light plant cabinet; Manual-Run-Off. Remote Run Switch in Remote Run position. Compartment overheat detection switch in normal position.

## Air Brakes and Train Handling Rule Changes

---

3. Place the two large breaker switches at the bottom of Electrical Cabinet A in the UP position.
4. Place the engine breaker switches up on both generator's panels in Electric Cabinet A.
5. One generator must be selected as the primary generator.
6. For the unit that has been selected as the primary generator, place Generator On-Off-Auto switch to the ON position.
7. On the other panel, place the Generator On-Off-Auto switch to the AUTO position.
8. Place the Primary Generator Selector Switch to correspond with primary generator selected in #6.
9. Place the Secondary Generator Selector Switch to same as selected in #7.
10. Place HEP receive Enable-Off-HEP feed enable switch to HEP feed enable position.
11. Place Trainline Control Switch to OFF.
12. Wait until both generators come on and both corresponding red Generator Contractor Closed Indicator lights are on, indicating generators are paralleled.
13. Place Trainline Control Switch to HEP feed.

### **BAGGAGE CAR SHUTDOWN PROCEDURE:**

1. Place the Trainline Control Switch to OFF.
2. Place the HEP Receive Enable - HEP Feed Enable Switch to OFF.
3. Place the generator On-Off Auto switch to OFF for both generators.
4. Leave all other switches alone.
5. Leave Engine Breaker Switch ON. This is an emergency switch only.
6. Engines are on a three minute timer before shutting off.
7. When the baggage car power will be shut down for more than six hours, the engine breaker switches should be shut off after the engines shut down on the three minute timer.

**SETUPFORPOWERINGTRAINWITHANOTHERHEP:**

1. If generators are running, go through the shut down procedures.
2. The 480 volt jumper must be removed from the front baggage car (Fireman's side).
3. Plug the 480 volt cables from the front HEP unit to the front of the baggage car.
4. The front HEP unit must have a 480 volt jumper on the rear (Engineer's side) unless cables are run down both sides of the train.
5. For power inside baggage car, place HEP Receive Enable-Off-HEP feed enable switch to HEP Receive Enable.

**HOUSEPOWERTO BAG CAR:**

1. Place HEP Receive Enable-Off-HEP feed enable switch to HEP Receive Enable.

**86.6 EN ROUTE OPERATION OF GVS  
(GENERATOR VANS) GV-01, GV-02,  
GV-03**

Each Generator Van has two generators on board. The GV-01 is capable of running both generators at the same time. The GV-02 and GV-03 are designed to only operate one generator at a time. The following instructions are designed to assist the trainmen in the proper shut down and restart of a generator.

**SHUTDOWN**

- 1) After entering the van from the end, turn the timer light switch on which is located to the right as you enter the door.
- 2) Check the indicator lights on the control panel to see the possible cause of the shutdown. If the "High Temperature" light or the "Oil Pressure" light is illuminated there is coolant and oil on-board for you to add.
- 3) Turn the Start Switch located on the front of the Control Panel to the "OFF" position or the "OFF/RESET" position depending on which GV you're on.

## Air Brakes and Train Handling Rule Changes

---

- 4) On the GV-01/GV-02, turn the Field Switch located on the left side of the generator box as you face the Control Panel to the “OFF” position. The GV-03 does not have a Field Switch.
- 5) Make sure the Generator Circuit Breaker that corresponds to that Generator is in the “OFF” (all the way down) position.
- 6) If a restart of the engine is not possible, turn the battery switch located near the floor on the right side of the engine as you face the Control Panel to the “OFF” (vertical) position.

The Generator has now been properly shut down.

### STARTUPPROCEDURE

If a restart or a start up of the other generator is desired, use the following steps for starting a generator after turning the battery switch on.

- 1) On the GV-01 and 02, turn the Field Switch to the OFF position.
- 2) On the GV-01, turn the Start Switch to the START position until it starts and then release and it will automatically go to the “ON” position. On the GV-02 and 03, turn the OFF/RESET/RUN switch to the RUN position.
- 3) On the GV-01, adjust the RPMs (Hertz) to 60 by rotating the manual throttle located on the right side as you face the Control Panel. On the GV-02, adjust the RPMs using the electric speed control switch on the control panel. The GV-03 is all automatic and requires no adjustment.
- 4) On the GV-01 and 02, turn the Field Switch to the “ON” position.
- 5) Move the Generator Circuit Breaker to the “ON” position.
- 6) On the GV-02 and GV-03, turn on the plug circuit breakers located at the right of the circuit breaker panel. These breakers are labeled #1 and #2. These numbers correspond to numbered tags on the cables at the trainline plugs.

NOTE: Depending on the quantity of KFF vans on the train, you may be utilizing one or both plugs. A visual check to make certain which plug and how many are being used should be performed before turning on the breakers. At this time the outside indicator lights should be illuminated.



## 86.7 END OF TRAIN DEVICES

If a train is required to be equipped with a two-way end-of-train device (reference document: *From the Desk of the Road Foreman, "Trains that require 2-way telemetry,"* dated September 17, 2002), it may not leave a terminal without a two-way end-of-train device (EOTD) that is armed and working properly.

If an EOTD fails, one of the following failure indications is displayed:

- DEAD BAT
- REPL BAT
- VALVFAIL
- DISARMED
- FRNOCOM

If this failure occurs while en route:

- **Do not exceed 30 mph until the failure is corrected or you have determined by another method there is brake pipe continuity throughout the train;**
- **Inform the dispatcher immediately, providing the EOTD number and the failure indication.**

If the failure occurs **before** ascending or descending steep grades, the train **must stop**, consistent with good train handling, and not proceed until the failure is corrected or you have determined there is brake pipe continuity throughout the train.

This instruction applies to the following grades:

- **Seward Subdivision**
  - MP 7 to MP 11.6
  - MP 45 to MP 53.7

If the failure occurs **while** ascending or descending one of these grades, it may be safer to proceed rather than stop. The engineer will determine if it is safe to continue by observing the information on air gauges or information displayed on the FIRE screen. (An increase or decrease in air flow, or a brake pipe pressure reduction of 5 psi or more, can indicate a jeopardized brake pipe system.)

## Air Brakes and Train Handling Rule Changes

---

If the engineer determines it is safe to proceed based on the information above:

- Reduce speed to 30 mph or less and attempt to restore communication;
- Proceed to the next location where it is safe to stop and attempt to restore communication.

If unable to restore communication, position a crewman at the rear of the train to help establish or confirm brake pipe continuity. If brake pipe continuity is confirmed, the train may continue to a location where the failed device can be replaced or repaired, whichever is reached first, observing the restrictions above.

In all cases, the engineer and train crew will follow all requirements for:

- Displaying and inspecting markers;
- Conducting air brake tests;
- Reporting clear of limits.

**Trains that must be divided into multiple sections in order to traverse a grade are exempt from the requirement for the use of a two-way end-of-train device. This exemption applies only to the extent necessary to traverse the grade and only while the train is divided into multiple sections for such purposes.**

Note: Normal LCU to EOT communications is at a much lower strength than the command to initiate an emergency application from the LCU to the EOT. In the event of a need to utilize the emergency feature of the EOT, the command to initiate an emergency must be attempted even if no communication is indicated at the LCU.

Conductors are responsible for the care and proper handling of their end-of-train device (EOT).

- Always carry the EOT by the handle with the light and reflector toward your body. EOT must be handled carefully at all times to prevent damage.
- Cars or locomotives must not be permitted to couple to the end of car attached to the EOT.
- Follow instructions posted at locations where EOTs are stockpiled for recharging and storage information.

Spare End-of-Train (EOT) devices are located in the following places: Talkeetna - in the section house; Hurricane - in the generator shack (southwest corner); and Healy - in the fax room at the Fire Hall.

## **86.8 BRAKE CUTOUTS ON LOCOMOTIVES**

**All locomotives are equipped with locomotive brake cutouts on each truck. This cutout is located on the engineer's side of the locomotive. When this cutout is used, it will only cut out the brakes on both side of that locomotive truck.**

**The Mechanical Department has made a modification to this and has added a brake cutout on each locomotive truck located on the fireman's side of the locomotive. If this cutout is used, it will only cut out the brakes on the fireman's side of that locomotive truck.**

**If a problem should arise and the brakes on the locomotive need to cut out, the brake cutout on the engineer's side must be utilized. Also, when performing a locomotive air brake test, both sides of the locomotive must be checked to ensure that the locomotive brakes are applying on each side.**

*Courtesy  
and  
Common Sense  
Promote Safety.*

*The road to the  
finish line is not  
always smooth. A  
positive attitude  
will set the right  
mood*

**90.0 HAZARDOUS MATERIAL  
HANDLING**

**90.1 HAZARDOUS MATERIAL HANDLING  
INSTRUCTIONS BOOKLET**

The Hazardous Material Handling Instructions booklet, issued November 1, 1998, is in effect. This document is separate from, but is an integral part of the Timetable, and this Timetable cannot be considered complete without it.

*Communicate*

---

*Assume Nothing*

## Appendix A.

### JOB BRIEFING

#### STEP 1: Plan the job briefing:

##### A. Develop your own work plan by:

1. Reviewing work or task to be accomplished.
2. Checking job location and work area:  
Know the condition of gates, switches, derails, track conditions, close clearances, short spurs, bad footing, and that cars are secure before coupling.
3. Breaking the work or task down into step-by-step procedure.
4. Determining tool, equipment, and material requirements.
5. Determining what safety rules or procedures are applicable. Consider close clearances and gates, etc.

##### B. Consider existing and potential hazards that might be involved as a result of:

1. Job and weather conditions.
2. The nature of the work to be done. Consider switching, spotting, picking up or setting out.
3. The job locations, consider whether yard, industry, or road.
4. The tools, equipment, and materials used.
5. Equipment to be worked on.
6. Traffic conditions and visibility. Consider people, vehicles, time of day, other jobs in track area, and obstructions.
7. Time of day. Consider whether 0:300-0:500 (alertness), or end of shift (“go home” moves).
8. Safety or personal protective equipment required.

##### C. Consider how work assignments will be made:

1. Group assignments: remember that the whole crew is a team and will be held jointly responsible.

2. Individual assignments: (who checks for what?)  
Engineers need to check with crew about the status of the gates, switches, derails, hand brakes, how much room, how many cars?
3. Abilities, experiences of individuals. Make sure that each crew member is able to do his/her assignment (experience, mental state, and physical condition).

### **STEP 2: Conduct the Job Briefing:**

#### **A. Explain work or task to involved employees:**

1. What is to be done.
2. Why is it to be done.
3. When it is to be done.
4. Where is it to be done.
5. How it is to be done. Everyone needs to understand what signals will be used. If radio, know the condition of the radio and verify the correct radio channel.
6. Who is to do it. Who will open and secure gates, line switches, line derails, make the cut or joint, protect the move.
7. What safety precautions are necessary. All crew members must know that the following are done:  
Gates open, switches lined, derails lined, cars not attached to the facility (plates and hose removed), cars secured before coupling, sufficient room has been verified for the move. Identify close clearances and bad footing. Engineers must not move until direction and distance has been received, and will stop after moving 1/2 the distance given unless further instructions are received.

#### **B. Discuss existing or potential hazards and ways to eliminate or protect against them.**

#### **C. Make definite work assignments.**

1. Make sure employees understand assignments
2. Ask questions of the "how" and "why" type.

#### **D. If special tools, material equipment, or methods are to be used, make sure employees know how to proceed safely.**



**E. Issue all instructions clearly and concisely, check to see that they are understood.**

**STEP 3: Job brief for special conditions:**

**A. Complex jobs:**

1. Brief only a portion of the job.
2. Give additional briefing as the job progresses.

**B. Change in job conditions - when it becomes necessary to change plans and procedures as the job progresses, brief employees on these changes (i.e. weather conditions change).**

**STEP 4: Follow up: Supervisor:**

**A. It is important that frequent checks be made as the work progresses to ensure that:**

1. Your plans are being followed and correct work methods used.
2. Each individual is carrying out the assignment responsibilities.
3. Any hidden hazards have been identified and action initiated to eliminate or what precautions are required.

**STEP 5: Individual Responsibility: All employees are responsible to see that the work plan is carried out according to the job briefing or modification when conditions change.**

**STEP 6: Debriefing**

- A. Review what went right.**
- B. Discuss any unexpected occurrences.**
- C. Discuss ideas for improvement.**
- D. Recognize good performance.**

**Constant Communication is Necessary and Required.**

***Job briefing . . .  
An injury  
prevention device***

---

# Index

## A

Abbreviations, Station Column 9  
Advance Restricted Clearance Sign 113  
Advance Warning Slide Zone Sign 109  
Advance Warning Speed Control Sign 107  
Advance Yard Limit Sign 106  
Air Brake and Train Handling Rules 131  
Airport Branch Junction, MP J 0.0 22  
Airport Terminal 22  
Alaska Railroad Safety Manual 125  
Anchorage 43  
Anchorage International Airport Branch 21  
Anchorage International Airport Terminal, MP J 2.4 22  
Anchorage Subdivision Call-Up Stations 43  
Anchorage Subdivision Excepted Track 42  
Anchorage Subdivision Grade Profiles 71  
Anchorage Subdivision Location of Other Tracks 40  
Anchorage Subdivision Maximum Authorized Speeds 37  
Anchorage Subdivision Measured Miles 42  
Anchorage Subdivision Method of Operation 37  
Anchorage Subdivision Siding Switch Locations 39  
Anchorage Subdivision Special Instructions 35  
Anchorage Subdivision Station Column 35  
Anchorage Yard Excepted Track 45  
Appendix A, Job Briefing 149  
Avalanche Detection System 88

## B

Bear Creek 58  
Bear Valley 32  
Begin Block Sign 114  
Begin CTC Sign 115  
Birchwood 46  
Branches, Anchorage International Airport 21  
Branches, Eielson 68  
Branches, Fairbanks International Airport 66

Branches, Palmer 63  
Branches, Suntrana 65  
Bridge and Tunnel Warning Sign 111  
Bridge Sign 111  
Bridges, Movement Over 88  
Broad Pass 53  
Brookman 19  
Browne 58

## C

Call-Up Stations, Anchorage Subdivision 43  
Call-Up Stations, Seward Subdivision 15  
Campbell 20  
Cantwell 53  
Canyon 51  
Carlo 54  
Carlo House Track MP 333.7 53  
Cascade Outfit Track 54  
Caswell 49  
Chase 51  
Chulitna 52  
Clear Site 59  
Clearance Diagrams 83  
Clearance of High, Wide and Heavy Loads 82  
Coal Loading Instructions 57  
Colorado 52  
Command Center 1  
Communications, Radio 100  
CP 1139 20  
Crossing Gates, Whittier Tunnel 31  
Crossing Signals 93  
Crown Point 16  
Curry 51

## D

Defect Detectors 89  
Denali Park 54  
Derail Post 112  
Derail Sign for Switch Stand 112  
Derails 79  
Detector, Type "A" 90

---

Detector, Type “B” 90  
Detector, Type “C” 91  
Detector, Type “D” 91  
Detector Type, Location and Operating Radio Freque 92  
Determining Number of Hand Brakes to Apply 116  
Dispatcher Call on Touch Pad-Equipped Radios 103  
Divide 16  
Dome 61  
Doubling Grandview Hill 17  
Dragging Equipment Detectors and/or Defect Detecto 89  
Dunbar 60

**E**

Eielson Branch 68  
Eielson Branch Location of Other Tracks 68  
Eielson Branch Maximum Authorized Speeds 68  
Eielson Branch Method of Operation 68  
Eielson Branch Special Instructions 69  
Eklutna 47  
End Block Sign 114  
End CTC Sign 116  
End of Track Sign 113  
End of Train Devices 143  
Excepted Track, Anchorage Subdivision 42  
Excepted Track, Anchorage Yard 45  
Excepted Track, Seward Subdivision 14  
Excepted Track, Whittier Subdivision 26  
Excepted Tracks, Fairbanks Yard 62  
Excessive Height Cars and Loads 81  
Export Coal Loading Instructions 57

**F**

Fairbanks 61  
Fairbanks International Airport Branch 66  
Fairbanks Intl. Airport Branch Location of Other T 66  
Fairbanks Intl. Airport Branch Maximum Authorized 66  
Fairbanks Intl. Airport Branch Method of Operation 66  
Fairbanks Intl. Airport Branch Special Instruction 67  
Fairbanks Yard Excepted Tracks 62  
Ferry 58  
Fixed Signals 106

Flag Location 127  
Flagging Distance 75  
Flanger Sign 107  
Fort Richardson 46  
Foul Time, Whittier Tunnel 31

## G

Game Animals/Livestock 106  
Garner 54  
Garner Tunnel 55  
General Code of Operating Rules 117  
General Orders 75  
Girdwood 19  
Gold Creek 51  
Grade Crossing/Highway Crossing Cross Reference 95  
Grade Profile, Seward Subdivision 22  
Grade Profile, Whittier Subdivision 32  
Grade Profiles, Anchorage Subdivision 71  
Grandview 17  
Grandview Hill, Doubling 17

## H

Hand Brakes, Determining Number to Apply 116  
Handling Heavy Equipment 80  
Happy 61  
Hazardous Material Handling 147  
Hazardous Material Handling Instructions Booklet 147  
Healy 55  
Healy Canyon Between Denali Park and Healy 55  
Heavy Equipment, Loading and Handling 80  
Heavy, High and Wide Loads, Clearing 82  
Heavy Loads 84  
High, Wide and Heavy Loads, Clearing 82  
Highway Crossing Signals 93  
Highway Crossing/Grade Crossing Cross Reference 95  
Honolulu 52  
Hopper Car Loading Capacity 84  
Houston 49  
Hunter 16  
Hurricane 52

**I**

Indian 19  
Instructions for Handling Special Equipment 76

**J**

Job Briefing 149

**K**

Kashwitna 49

**L**

Livestock/Game Animals 106  
Loading and Handling Heavy Equipment 80  
Loading Capacity, Hopper Car 84  
Loading Clearance Diagrams 83  
Loading Placement of TOFC Containers 85  
Local Coal Loading Instructions 58  
Location of Other Tracks, Anchorage International 21  
Location of Other Tracks, Anchorage Subdivision 40  
Location of Other Tracks, Eielson Branch 68  
Location of Other Tracks, Fairbanks Intl. Airport 66  
Location of Other Tracks, Palmer Branch 63  
Location of Other Tracks, Seward Subdivision 13  
Location of Other Tracks, Whittier Subdivision 26  
Log Track MP 223.6 50

**M**

Maintenance of Way Radios 105  
Maintenance Track MP 401.1 59  
Malfunctioning Crossing Signal Sign 115  
Manley 60  
Matanuska 47  
Maximum Authorized Speeds 76  
Maximum Authorized Speeds, Anchorage International 21  
Maximum Authorized Speeds, Anchorage Subdivision 37  
Maximum Authorized Speeds, Eielson Branch 68  
Maximum Authorized Speeds, Fairbanks Intl. Airport 66  
Maximum Authorized Speeds, Palmer Branch 63  
Maximum Authorized Speeds, Seward Subdivision 12  
Maximum Authorized Speeds, Suntrana Branch 65

Maximum Authorized Speeds, Whittier Subdivision 25  
Maximum Speeds Permitted 76  
Measured Mile Signs 107  
Measured Miles, Anchorage Subdivision 42  
Measured Miles, Seward Subdivision 14  
Measured Miles, Whittier Subdivision 26  
Method of Operation, Anchorage International Airpo 21  
Method of Operation, Anchorage Subdivision 37  
Method of Operation, Eielson Branch 68  
Method of Operation, Fairbanks Intl. Airport Branc 66  
Method of Operation, Palmer Branch 63  
Method of Operation, Seward Subdivision 12  
Method of Operation, Suntrana Branch 65  
Method of Operation, Whittier Subdivision 25  
Mile Post Sign 111  
Mile Posts 394 A and 394 B 59  
Minimum Flagging Distance 75  
Montana 49  
Montana Creek Bridge, MP 211 50  
Moody Tunnel 55  
Moose Pass 16  
Movement Over Bridges 88  
MP 117 Crossover to SW MP 119.8 45  
MP 123 46  
MP 131 Powder Spur 46  
MP 158.7 Spenard Builders Supply 48  
MP 161.6 Spenard Builders Supply 48  
MP 223.6 Log Track 50  
MP 333.7 House Track 53  
MP 388 Pit Track 58  
MP 401.1 Maintenance Track 59  
MP 432.6 Outfit Track 60  
MP 50 17

## **N**

Nenana 59  
North Nenana 60

## **O**

Oliver 54  
On-Track Movements Through Whittier Tunnel 30



---

Operating Circulars 75  
Outfit Track MP 432.6 60  
OVL 20

## **P**

Palmer Branch 63  
Palmer Branch Location of Other Tracks 63  
Palmer Branch Maximum Authorized Speeds 63  
Palmer Branch Method of Operation 63  
Palmer Branch Special Instructions 64  
Palmer Junction 47  
Pit Track MP 388 58  
Pittman 48  
Portage, Seward Subdivision 18  
Portage Tunnel Doors 28  
Portage, Whittier Subdivision 32  
Potter 19  
Powder Spur MP 131 46

## **Q**

QAP MP 108.4 20

## **R**

Radio Base and Wayside Station Locations, Times At 105  
Radio Communications 100  
Radio Telephone Operation 104  
Radios, Maintenance of Way 105  
Rainbow 19  
Restricted Clearance Sign 113  
Resume Speed Sign 108  
Reves 46  
Road Crossing Warning Sign 110

## **S**

Safety Manual 125  
Saulich 61  
Securing Caboose Doors 139  
Setting Out Cars 80  
Seward 15  
Seward Subdivision 11

Seward Subdivision Call-Up Stations 15  
Seward Subdivision Excepted Track 14  
Seward Subdivision Grade Profile 22  
Seward Subdivision Location of Other Tracks 13  
Seward Subdivision Maximum Authorized Speeds 12  
Seward Subdivision Measured Miles 14  
Seward Subdivision Method of Operation 12  
Seward Subdivision Siding Switch Locations 14  
Seward Subdivision Station Column 11  
Sherman 51  
Siding Switch Location, Whittier Subdivision 26  
Siding Switch Locations, Anchorage Subdivision 39  
Siding Switch Locations, Seward Subdivision 14  
Sidings, Train Operations 76  
Sign, Advance Restricted Clearance 113  
Sign, Advance Warning Slide Zone 109  
Sign, Advance Warning Speed Control 107  
Sign, Advance Yard Limit 106  
Sign, Begin Block 114  
Sign, Begin CTC 115  
Sign, Bridge 111  
Sign, Bridge and Tunnel Warning 111  
Sign, Derail for Switch Stand 112  
Sign, End Block 114  
Sign, End CTC 116  
Sign, End of Track 113  
Sign, Flanger 107  
Sign, Malfunctioning Crossing Signal 115  
Sign, Measured Mile 107  
Sign, Mile Post 111  
Sign, Restricted Clearance 113  
Sign, Resume Speed 108  
Sign, Road Crossing Warning 110  
Sign, Slide Zone - Back 110  
Sign, Slide Zone - Front 109  
Sign, Speed Control 108, 109  
Sign, Station 112  
Sign, Station Warning 110  
Sign, Temporary Speed Restriction 114  
Sign, Tunnel Approach 111  
Sign, Yard Limit 106  
Signal Aspects and Indications 165

---

Signals, Fixed 106  
Slide Zone Sign - Back 110  
Slide Zone Sign - Front 109  
Slide Zones 86  
Snow Fleet Track MP 62.8 18  
Special Instructions, All Subdivisions 75  
Special Instructions, Anchorage Subdivision 35  
Special Instructions, Eielson Branch 69  
Special Instructions, Fairbanks Intl. Airport Bran 67  
Special Instructions, Seward Subdivision 11  
Special Instructions, Suntrana Branch 65  
Special Instructions, Whittier Subdivision 25  
Speed Control Sign 108, 109  
Speed Table 163  
Spenard Builders Supply MP 158.7 48  
Spenard Builders Supply MP 161.6 48  
Spencer 17  
Spencer Pit Track MP 55.82 18  
Standard 61  
Station Column Abbreviations 9  
Station Column, Anchorage Subdivision 35  
Station Sign 112  
Station Warning Sign 110  
Summit 53  
Sunshine 50  
Suntrana Branch 65  
Suntrana Branch Maximum Authorized Speeds 65  
Suntrana Branch Method of Operation 65  
Suntrana Branch Special Instructions 65  
Susitna 51  
SW MP 119.8 to MP 117 Crossover 45  
Switch Alignment 78  
Switch Point Derails, Whittier Tunnel 31  
Switching/Train Makeup Restrictions 79

## T

Talkeetna 50  
Telephones, Whittier Subdivision Tunnels 29  
Temporary Speed Restriction Sign 114  
TOFC Containers, Loading Placement 85  
Track and Time 75  
Train Handling and Air Brake Rules 131

Train Makeup Restrictions 79  
Train Operations at Sidings 76  
Tunnel 17  
Tunnel and Bridge Warning Sign 111  
Tunnel Approach Sign 111  
Tunnel Door Locations, Whittier Subdivision 26  
Tunnel Doors, Portage Tunnel 28  
Tunnels, Whittier Subdivision 28  
Turnagain 20  
Type "A", Dragging Equipment Detector 90  
Type "B", Dragging Equipment/Hot Bearing Detector 90  
Type "C", Dragging Equipment/Hot Bearing/Hot Wheel 91  
Type "D", Dragging Equipment Detector 91

## U

Usibelli Tipple 56

## W

Wasilla 48  
Whittier 27  
Whittier Subdivision Excepted Track 26  
Whittier Subdivision Grade Profile 32  
Whittier Subdivision Measured Mile 26  
Whittier Subdivision Method of Operation 25  
Whittier Subdivision Special Instructions 25  
Whittier Subdivision Station Column 25  
Whittier Subdivision Tunnel Door Locations 26  
Whittier Subdivision Tunnels 28  
Whittier Subdivision Tunnels Telephones 29  
Whittier Tunnel Crossing Gates 31  
Whittier Tunnel Foul Time 31  
Whittier Tunnel On-Track Movements 30  
Whittier Tunnel Signal System 29  
Whittier Tunnel Signal System Malfunction 32  
Whittier Tunnel Switch Point Derails 31  
Wide, High and Heavy Loads, Clearing 82  
Willow 49  
Windy 53

## Y

Yard Limit Sign 106

**SPEED TABLE**

Time Per Mile		Miles Per Hour	Time Per Mile		Miles Per Hour
Min	Sec		Min	Sec	
1	1	59	2	37	22.9
1	5	55.4	2	44	22
1	10	51.4	2	52	20.9
1	15	48	3	0	20
1	20	45	3	10	19
1	25	42.4	3	20	18
1	30	40	3	32	17
1	35	37.9	3	45	16
1	40	36	4	0	15
1	43	35	4	17	14
1	45	34.3	4	36	13
1	50	32.7	5	0	12
1	55	31.3	5	27	11
2	0	30	6	0	10
2	5	28.8	6	40	9
2	10	27.7	7	30	8
2	15	26.7	8	34	7
2	20	25.7	10	0	6
2	24	25	12	0	5
2	30	24	15	0	4

**Note: Speed can also be estimated by counting number of rail joints, on tangent track, passed over in 27 ½ seconds. This number will equal approximate miles per hour.**

**Note:**

.1 mile equals 528 feet  
.2 mile equals 1056 feet  
.3 mile equals 1584 feet  
.4 mile equals 2112 feet  
.5 mile equals 2640 feet

.6 mile equals 3168 feet  
.7 mile equals 3696 feet  
.8 mile equals 4224 feet  
.9 mile equals 4752 feet  
1.0 mile equals 5280 feet





***G.O.A.L.S.-  
Good Overall  
Attitude Leads to  
Success.***

## **Rule 9.1 Signal Aspects and Indications**

**DISTANT SIGNALS:** Any signal aspect more favorable than Restricting may be displayed with a “D” sign on the signal mast to identify the signal as a distant signal. When a “D” sign is displayed, if train is delayed per GCOR Rule 9.9 between a distant signal and the next signal, proceed prepared to stop short of the next signal.

Aspects shown with  indicate the light will flash.

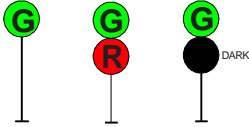
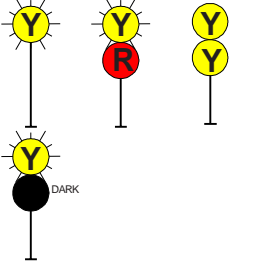
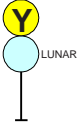
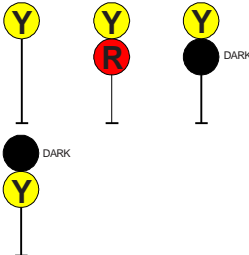

# Signal Aspects and Indications

Rule	Aspect	Name	Indication
9.1.1		DISTANT SIGNAL CLEAR	Proceed. If delayed as per Rule 9.9 or Rule 9.9.1 between this signal and block or interlocking signal, proceed prepared to stop at next signal.
9.1.2		DISTANT SIGNAL APPROACH	Approach next signal prepared to stop short of signal.
9.1.3		CLEAR	Proceed.
9.1.6		APPROACH MEDIUM	Proceed prepared to pass next signal not exceeding <b>30 MPH</b> and be prepared to enter diverging route at prescribed speed.
9.1.7		APPROACH RESTRICTING	Proceed prepared to pass next signal at restricted speed.
9.1.8		APPROACH	Proceed prepared to stop at next signal; trains exceeding <b>30 MPH</b> immediately reduce to that speed.
9.1.9		DIVERGING CLEAR	Proceed on diverging route not exceeding prescribed speed through turnout.

**G=GREEN Y=YELLOW R=RED**

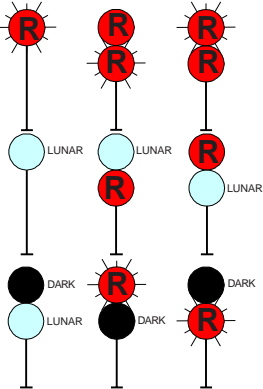
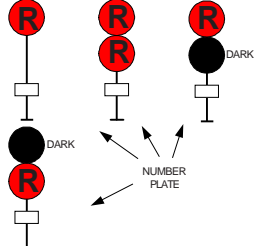
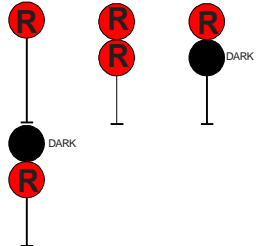

# Signal Aspects and Indications

Rule	Aspect	Name	Indication
9.1.11		DIVERGING APPROACH MEDIUM	Proceed on diverging route not exceeding prescribed speed through turnout prepared to pass next signal not exceeding 35 MPH.
9.1.12		DIVERGING APPROACH	Proceed through diverging route; prescribed speed through turnout; approach next signal prepared to stop. If exceeding 30 MPH immediately reduce to that speed.
9.1.13		RESTRICTING	Proceed at restricted speed.
9.1.14		STOP AND PROCEED	Stop, then proceed at restricted speed.
9.1.15		STOP	Stop.

**G=GREEN Y=YELLOW R=RED**

Asking me to overlook an **UNSAFE WORK PRACTICE** is like asking me to overlook the value I place on your **LIFE**.

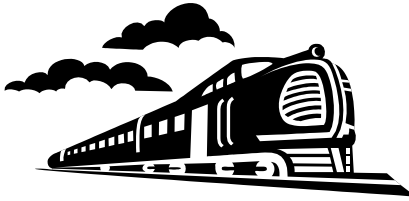

*Don't make your last move, your last move.*

***I CHOSE TO LOOK THE OTHER WAY***

I chose to look the other way  
I could have saved a life that day,  
But I chose to look the other way.  
It wasn't that I didn't care,  
I had the time, and I was there.  
But I didn't want to seem a fool,  
Or argue over a safety rule.  
I knew he'd done the job before,  
If I called it wrong, he might get sore.  
The chances didn't seem that bad,  
I've done the same, he knew I had.  
So I shook my head and walked on by,  
He knew the risks as well as I.  
He took a chance, I closed an eye,  
And with that act I let him die.  
I could have saved a life that day,  
But I chose to look the other way.  
Now every time I see his wife,  
I'll know I should have saved his life.  
That guilt is something I must bear,  
But it isn't something you need to share.  
If you see a risk that others take,  
That puts their health or life at stake,  
The question asked, or the thing you say,  
Could help them live another day.  
If you see a risk and walk away,  
Then hope you never have to say,  
I could have saved a life that day,  
But I chose to look the other way.

## WIND CHILL

The wind chill is based on the rate of heat loss from exposed skin caused by the combined effects of wind and cold temperatures. As the wind increases heat is carried away from the body at an accelerated rate, driving down the body temperature. A strong wind combined with a temperature of just below freezing can have the same effect as a still air temperature which is 35 degrees colder. People and animals are affected by wind chill but inanimate objects (such as vehicles) are not.

### WIND CHILL CHART

#### TEMPERATURE (°F)

		35	30	25	20	15	10	5	0	-5	-10	-15	-20	-25	-30
<b>W</b>	5	31	25	19	13	7	1	-5	-11	-16	-22	-28	-34	-40	-46
	10	27	21	15	9	3	-4	-10	-16	-22	-28	-35	-41	-47	-53
<b>S</b>	15	25	19	13	6	0	-7	-13	-19	-26	-32	-39	-45	-51	-58
	20	24	17	11	4	-2	-9	-15	-22	-29	-35	-42	-48	-55	-61
<b>E</b>	25	23	16	9	3	-4	-11	-17	-24	-31	-37	-44	-51	-58	-64
	30	22	15	8	1	-5	-12	-19	-26	-33	-39	-46	-53	-60	-67
<b>M</b>	35	21	14	7	0	-7	-14	-21	-27	-34	-41	-48	-55	-62	-69
	40	20	13	6	-1	-8	-15	-22	-29	-36	-43	-50	-57	-64	-71
<b>H</b>	45	19	12	5	-2	-9	-16	-23	-30	-37	-44	-51	-58	-65	-72

**+ 20 TO - 18** Work outside becomes unpleasant. Hats, coats and gloves are needed.

**- 19 TO - 34** Work outside becomes more hazardous. Heavy outer wear clothing is needed.

**- 35 TO - 49** Frostbite can occur with prolonged exposure. Heavy outer clothing is essential.

**- 50 TO - 79** Frostbite can occur within a minute. Face protection is important. Multiple layers of clothing are essential.

**- 80 TO - 99** Frostbite can occur in 30 to 60 seconds. Work outside is dangerous.

**Less than - 99** Frostbite occurs in less than 30 seconds. People working outside will become easily fatigued. Outdoor work or travel is very dangerous.

